

**PHILIPS**

Professional  
Display Solutions

L Line

41BDL7224L

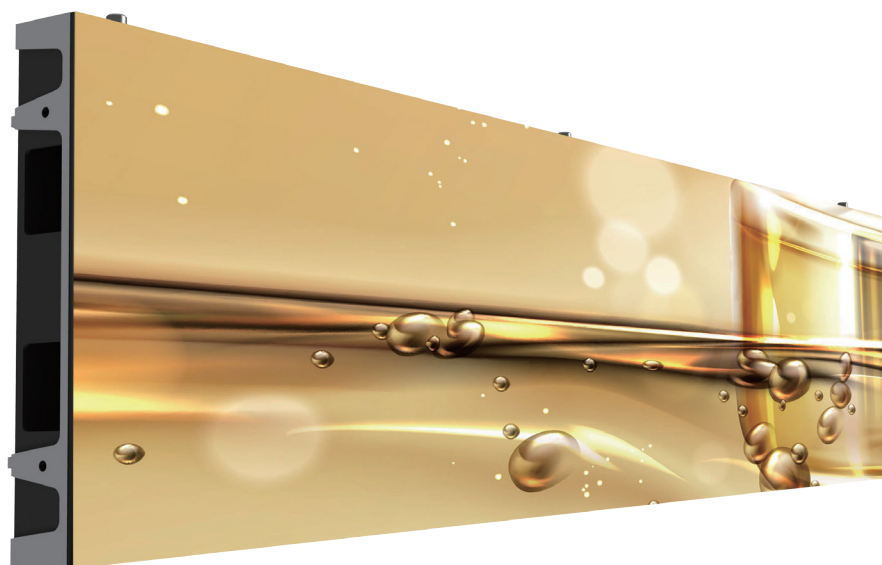

[www.philips.com/welcome](http://www.philips.com/welcome)

User Manual (English)

# Safety Instructions

## Read this first

The latest User's Manual, Quick Start Guide and FAQ are available for download from the Philips website.

## Warning & Symbols

Refer to the following graphic symbols to alert you to important information:



Notes: useful information that help you get better use of the product.



Cautions: notices describing actions that may damage your product.



Warnings: instructions that must be followed. Failure to observe may damage your product.

## Safety guidelines



Use of controls, adjustments or procedures other than those specified in this documentation may result in exposure to shock, electrical hazards and/or mechanical hazards.

## Safety precautions and maintenance



**WARNING:** Use of controls, adjustments or procedures other than those specified in this documentation may result in exposure to shock, electrical hazards and/or mechanical hazards.

## Read and follow these instructions when connecting and using your display:

### Operation:

- Keep the display out of direct sunlight and away from stoves or any other heat sources.
- Keep the display away from oil, otherwise the plastic cover may be damaged.
- It is recommended to set the display up in the well-ventilated place.
- Ultra-violet ray filter is necessary of outdoor operation.
- If the product will be used in extreme conditions such as high temperature, humidity, display patterns or operation time etc... It is strongly recommended to contact Philips for Application engineering advice. Otherwise, its reliability and function may not be guaranteed. Extreme conditions are commonly found at Airports, Transit Stations, Banks, Stock market, and Controlling systems.
- Remove any object that could fall into ventilation holes or prevent proper cooling of the display's electronics.
- Do not block the ventilation holes on the cabinet.
- When positioning the display, make sure the power plug and outlet are easily accessible.
- When turning off the display by detaching the power cord, wait 6 seconds before re-attaching the power cord for normal operation.
- Ensure the use of an approved power cord provided by Philips at all times. If your power cord is missing, please contact your local service center.
- Do not subject the display to severe vibration or high impact conditions during operation.
- Do not knock or drop the display during operation or transportation.
- The eye bolt is for usage in short-time maintenance and installation. We suggest not to use the eye bolt for more than 1 hour. Prolong usage is prohibited. Please keep a clear safety area under the display while using the eye bolt.

### Maintenance:

- To protect your display from possible damage, do not put excessive pressure on the LED display. When moving your display, grasp the frame to lift; do not lift the display by placing your hand or fingers on the LED display.
- Unplug the display if you are not going to use it for an extensive period of time.
- Unplug the display if you need to clean it with a slightly damp cloth. The screen may be wiped with a dry cloth when the power is off. However, never use organic solvent, such as, alcohol, or ammonia-based liquids to clean your display.
- To avoid the risk of shock or permanent damage to the set, do not expose the display to dust, rain, water or an excessively moist environment.
- If your display becomes wet, wipe it with dry cloth as soon as possible.
- If a foreign substance or water gets in your display, turn the power off immediately and disconnect the power cord. Then remove the foreign substance or water, and send the unit to the maintenance center.
- Do not store or use the display in locations exposed to heat, direct sunlight or extreme cold.
- In order to maintain the best performance of your display and ensure a longer lifetime, we strongly recommend using the display in a location that falls within the following temperature and humidity ranges.

### Environmental absolute ratings

| Item                  | Min. | Max. | Unit |
|-----------------------|------|------|------|
| Storage temperature   | -20  | 50   | °C   |
| Operation temperature | -20  | 45   | °C   |
| Storage humidity      | 10   | 85   | % RH |
| Operating humidity    | 10   | 80   | % RH |

- LED display temperature need to be 25 degrees Celsius at all time for better luminance performance.
- Only the lifetime of the display stated in this specification is guaranteed if the display is used under the proper operation conditions.

**IMPORTANT:** Always activate a moving screen saver program when you leave your display unattended. Always activate a periodic screen refresh application if the unit will display unchanging static content. Uninterrupted display of still or static images over an extended period may cause inconsistent display performance

### Service:

- The cabinet and LED modules should be installed or removed only by qualified service personnel.
- If there is any need for repair or integration, please contact your local service center.
- Do not leave your display under direct sunlight.



If your display does not operate normally, having followed the instructions set out in this document, please contact a technician or your local service center.

### Stability Hazard.

The device may fall, causing serious personal injury or death. To prevent injury, this device must be securely attached to the floor/wall in accordance with the installation instructions.

IEC/EN 62368: A product may fall, causing serious personal injury or death. Many injuries, particularly to children, can be avoided by taking simple precautions such as:

- ALWAYS use cabinets or stands or installation methods recommended by the manufacturer of the product set.
- ALWAYS use furniture that can safely support the product.
- ALWAYS ensure the product is not overhanging the edge of the supporting furniture.
- ALWAYS educate children about the dangers of climbing on furniture to reach the product or its controls.
- ALWAYS route cords and cables connected to your product so they cannot be tripped over, pulled or grabbed.
- NEVER place a product in an unstable location.
- NEVER place the product on tall furniture (for example, cupboards or bookcases) without anchoring both the furniture and the product to a suitable support.
- NEVER place the product on cloth or other materials that may be located between the product and supporting furniture.
- NEVER place items that might tempt children to climb, such as toys and remote controls, on the top of the product or furniture on which the product is placed.

If the existing product is going to be retained and relocated, the same considerations as above should be applied.

**Read and follow these instructions when connecting and using your display:**

- Unplug the display if you are not going to use it for an extensive period of time.
- Unplug the display if you need to clean it with a slightly damp cloth. The screen may be wiped with a dry cloth when the power is off. However, never use alcohol, solvents or ammonia-based liquids.
- Consult a service technician if the display does not operate normally when you have followed the instructions in this manual.
- The cabinet and LED modules should be installed or removed only by qualified service personnel.
- Keep the display out of direct sunlight and away from stoves or any other heat sources.
- Remove any object that could fall into the vents or prevent proper cooling of the display's electronics.
- Do not block the ventilation holes on the cabinet.
- Keep the display dry. To avoid electric shock, do not expose it to rain or excessive moisture.
- When turning off the display by detaching the power cable or DC power cord, wait for 6 seconds before re-attaching the power cable or DC power cord for normal operation..
- To avoid the risk of shock or permanent damage to the set do not expose the display to rain or excessive moisture.
- When positioning the display, make sure the power plug and outlet are easily accessible.
- If provided with a 3-pin attachment plug on the power cord, plug the cord into a grounded (earthed) 3-pin outlet. Do not disable the power cord grounding pin, for example, by attaching a 2-pin adapter. The grounding pin is an important safety feature.

**EU Declaration of Conformity**

This device complies with the requirements set out in the Council Directive on the Approximation of the Laws of the Member States relating to Electromagnetic Compatibility (2014/30/EU), Low-voltage Directive (2014/35/EU), RoHS directive (2011/65/EU).

This product has been tested and found to comply with the harmonized standards for Information Technology Equipment, these harmonized standards published under Directives of Official Journal of the European Union.

**ESD Warnings**

When user close to the monitor may cause the equipment discharge and reboot to the display of main menu while USB media is playing.

**Warning:**

This equipment is compliant with Class A of EN55032/CISPR 32. In a residential environment this equipment may cause radio interference.

**Federal Communications Commission (FCC) Notice (U.S. Only)**

**NOTE:** This equipment has been tested and found to comply with the limits for a Class A digital device, pursuant to part 15 of the FCC Rules. These limits are designed to provide reasonable protection against harmful interference when the equipment is operated in a commercial environment. This equipment generates, uses, and can radiate radio frequency energy and, if not installed and used in accordance with the instruction manual, may cause harmful interference to radio communications. Operation of this equipment in a residential area is likely to cause harmful interference in which case the user will be required to correct the interference at his own expense.



Changes or modifications not expressly approved by the party responsible for compliance could void the user's authority to operate the equipment.

Use only an RF shielded cable that was supplied with the display when connecting this display to a computer device. To prevent damage which may result in fire or shock hazard, do not expose this appliance to rain or excessive moisture.

This device complies with Part 15 of the FCC Rules. Operation is subject to the following two conditions: (1) This device may not cause harmful interference, and (2) this device must accept any interference received, including interference that may cause undesired operation.

Envision Peripherals Inc.  
490 N McCarthy Blvd, Suite #120  
Milpitas, CA 95035  
USA

## Polish Center for Testing and Certification Notice

The equipment should draw power from a socket with an attached protection circuit (a three-prong socket). All equipment that works together (computer, display, printer, and so on) should have the same power supply source.

The phasing conductor of the room's electrical installation should have a reserve short-circuit protection device in the form of a fuse with a nominal value no larger than 16 amperes (A).

To completely switch off the equipment, the power supply cable must be removed from the power supply socket, which should be located near the equipment and easily accessible.

A protection mark "B" confirms that the equipment is in compliance with the protection usage requirements of standards PN-93/T-42107 and PN-89/E-06251.

### *Wymagania Polskiego Centrum Badań i Certyfikacji*

Urządzenie powinno być zasilane z gniazda z przyłączonym obwodem ochronnym (gniazdo z kolkiem). Współpracujące ze sobą urządzenia (komputer, monitor, drukarka) powinny być zasilane z tego samego źródła.

Instalacja elektryczna pomieszczenia powinna zawierać w przewodzie fazowym rezerwową ochronę przed zwarciami, w postaci bezpiecznika o wartości znamionowej nie większej niż 16A (amperów).

W celu całkowitego wyłączenia urządzenia z sieci zasilania, należy wyjąć wtyczkę kabla zasilającego z gniazdka, które powinno znajdować się w pobliżu urządzenia i być łatwo dostępne.

Znak bezpieczeństwa "B" potwierdza zgodność urządzenia z wymaganiami bezpieczeństwa użytkownika zawartymi w PN-93/T-42107 i PN-89/E-06251.

### *Pozostałe instrukcje bezpieczeństwa*

- Nie należy używać wtyczek adapterowych lub usuwać kolka obwodu ochronnego z wtyczki. Jeżeli konieczne jest użycie przedłużacza to należy użyć przedłużacza 3-żyłowego z prawidłowo połączonym przewodem ochronnym.
- System komputerowy należy zabezpieczyć przed nagłymi, chwilowymi wzrostami lub spadkami napięcia, używając eliminatora przepięć, urządzenia dopasowującego lub bezzakłóceniewego źródła zasilania.
- Należy upewnić się, aby nic nie leżało na kablach systemu komputerowego, oraz aby kable nie były umieszczone w miejscu, gdzie można byłoby na nie nadeptywać lub potykać się o nie.
- Nie należy rozlewać napojów ani innych płynów na system komputerowy.
- Nie należy wpychać żadnych przedmiotów do otworów systemu komputerowego, gdyż może to spowodować pożar lub porażenie prądem, poprzez zwarcie elementów wewnętrznych.
- System komputerowy powinien znajdować się z dala od grzejników i źródeł ciepła. Ponadto, nie należy blokować otworów wentylacyjnych. Należy unikać kładzenia luźnych papierów pod komputer oraz umieszczania komputera w ciasnym miejscu bez możliwości cyrkulacji powietrza wokół niego.

## Electric, Magnetic and Electromagnetic Fields ("EMF")

1. We manufacture and sell many products targeted at consumers, which, like any electronic apparatus, in general have the ability to emit and receive electromagnetic signals.
2. One of our leading Business Principles is to take all necessary health and safety measures for our products, to comply with all applicable legal requirements and to stay well within the EMF standards applicable at the time of producing the products.
3. We are committed to develop, produce and market products that cause no adverse health effects.
4. We confirm that if its products are handled properly for their intended use, they are safe to use according to scientific evidence available today.
5. We play an active role in the development of international EMF and safety standards, enabling us to anticipate further developments in standardization for early integration in its products.

## Information for U.K. only

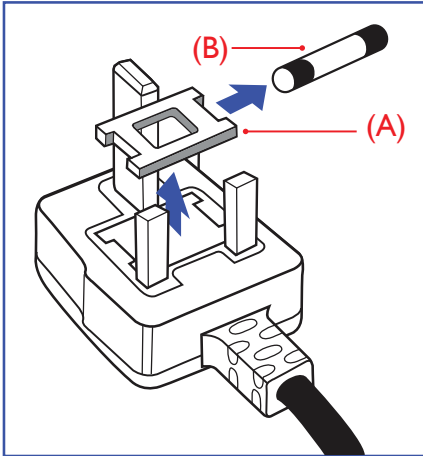

### WARNING - THIS APPLIANCE MUST BE EARTHED.

#### Important:

This apparatus is supplied with an approved moulded 13A plug. To change a fuse in this type of plug proceed as follows:+

1. Remove fuse cover and fuse.
2. Fit new fuse which should be a BS 1362 5A, A.S.T.A. or BSI approved type.
3. Refit the fuse cover.

If the fitted plug is not suitable for your socket outlets, it should be cut off and an appropriate 3-pin plug fitted in its place.

If the mains plug contains a fuse, this should have a value of 5A. If a plug without a fuse is used, the fuse at the distribution board should not be greater than 5A.

NOTE: The severed plug must be destroyed to avoid a possible shock hazard should it be inserted into a 13A socket elsewhere.

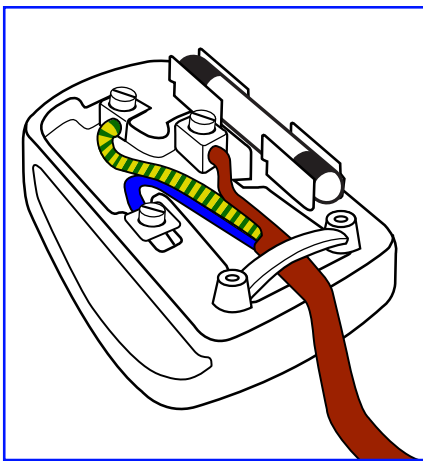

#### How to connect a plug

The wires in the mains lead are coloured in accordance with the following code:

BLUE - "NEUTRAL" ("N")

BROWN - "LIVE" ("L")

GREEN & YELLOW - "EARTH" ("E")

1. The GREEN & YELLOW wire must be connected to the terminal in the plug which is marked with the letter "E" or by the Earth symbol or coloured GREEN or GREEN & YELLOW.
2. The BLUE wire must be connected to the terminal which is marked with the letter "N" or coloured BLACK.
3. The BROWN wire must be connected to the terminal which marked with the letter "L" or coloured RED.

Before replacing the plug cover, make certain that the cord grip is clamped over the sheath of the lead - not simply over the three wires.

## North Europe (Nordic Countries) Information

Placering/Ventilation

#### VARNING:

FÖRSÄKRA DIG OM ATT HUVUDBRYTARE OCH UTTAG ÄR LÄTÅTKOMLIGA, NÄR DU STÄLLER DIN UTRUSTNING PÅPLATS.

Placering/Ventilation

#### ADVARSEL:

SØRG VED PLACERINGEN FOR, AT NETLEDNINGENS STIK OG STIKKONTAKT ER NEMT TILGÆNDELIGE.

Paikka/Ilmankierto

#### VAROITUS:

SIVOITA LAITE SITEN, ETTÄ VERKKOJOHTO VOIDAAN TARVITTAESSA HELPOSTI IRROTTAA PISTORASIESTA.

Plassering/Ventilasjon

#### ADVARSEL:

NÅR DETTE UTSTYRET PLASSERES, MÅ DU PASSE PÅ AT KONTAKTENE FOR STØMTILFØRSEL ER LETTE Å NÅ.

## China RoHS

根据中国大陆《电器电子产品有害物质限制使用管理办法》，以下部分列出了本产品中可能包含的有害物质的名称和含量。

| 部件名称   | 有害物质      |           |           |                  |               |                 |
|--------|-----------|-----------|-----------|------------------|---------------|-----------------|
|        | 铅<br>(Pb) | 汞<br>(Hg) | 镉<br>(Cd) | 六价铬<br>(Cr (VI)) | 多溴联苯<br>(PBB) | 多溴二苯醚<br>(PBDE) |
| 铁框     | ○         | ○         | ○         | ○                | ○             | ○               |
| 发光二极管  | X         | ○         | ○         | ○                | ○             | ○               |
| 电路板组件* | X         | ○         | ○         | ○                | ○             | ○               |
| 电源线    | X         | ○         | ○         | ○                | ○             | ○               |
| 其他线材   | X         | ○         | ○         | ○                | ○             | ○               |

本表格依据SJ/T 11364 的规定编制。

\*: 电路板组件包括印刷电路板及其构成的零部件，如电阻、电容、集成电路、连接器等。

○: 表示该有害物质在该部件所有均质材料中的含量均在 GB/T 26572规定的限量要求以下。

X: 表示该有害物质至少在该部件的某一均质材料中的含量超出GB/T 26572规定的限量要求。

上表中打“X”的部件，应功能需要，部分有害物质含量超出GB/T 26572规定的限量要求，但符合欧盟RoHS法规要求（属于豁免部分）。

备注：上表仅做为范例，实际标示时应依照各产品的实际部件及所含有害物质进行标示。



### 环保使用期限

此标识指期限（十年），电子电气产品中含有的有害物质在正常使用的条件下不会发生外泄或突变，电子电气产品用户使用该电子电气产品不会对环境造成严重污染或对其人身、财产造成严重损害的期限。

《废弃电器电子产品回收处理管理条例》提示性说明

为了更好地关爱及保护地球，当用户不再需要此产品或产品寿命终止时，请遵守国家废弃电器电子产品回收处理相关法律法规，将其交给当地具有国家认可的回收处理资质的厂商进行回收处理，不当利用或者处置可能会对环境和人类健康造成影响。

### 警告

此为 A 级产品。在生活环境中，该产品可能会造成无线电干扰。在这种情况下，可能需要用户对干扰采取切实可行的措施。

| 單元    | 限用物質及其化學符號 |           |           |                            |               |                 |
|-------|------------|-----------|-----------|----------------------------|---------------|-----------------|
|       | 鉛<br>(Pb)  | 汞<br>(Hg) | 鎘<br>(Cd) | 六價鉻<br>(Cr <sup>+6</sup> ) | 多溴聯苯<br>(PBB) | 多溴二苯醚<br>(PBDE) |
| 鐵框    | ○          | ○         | ○         | ○                          | ○             | ○               |
| 發光二極管 | —          | ○         | ○         | ○                          | ○             | ○               |
| 電路板組件 | —          | ○         | ○         | ○                          | ○             | ○               |
| 電源線   | —          | ○         | ○         | ○                          | ○             | ○               |
| 其他線材  | —          | ○         | ○         | ○                          | ○             | ○               |

備考1. “○” 係指該項限用物質之百分比含量未超出百分比含量基準值。  
備考2. “—” 係指該項限用物質為排除項目。

警語：使用過度恐傷害視力。

注意事項：

- (1) 使用30分鐘請休息10分鐘。
- (2) 未滿2歲幼兒不看螢幕，2歲以上每天看螢幕不要超過1小時。

警告使用者：

此為甲類資訊技術設備，於居住環境中使用時，可能會造成射頻擾動，在此種情況下，使用者會被要求採取某些適當的對策。

### Turkey RoHS:

Türkiye Cumhuriyeti: EEE Yönetmeliğine Uygundur

### Ukraine RoHS:

Обладнання відповідає вимогам Технічного регламенту щодо обмеження використання деяких небезпечних речовин в електричному та електронному обладнанні, затвердженого постановою Кабінету Міністрів України від 3 грудня 2008 № 1057

### End-of-Life Disposal

Your new Public Information Display contains materials that can be recycled and reused. Specialized companies can recycle your product to increase the amount of reusable materials and to minimize the amount to be disposed of.

Please find out about the local regulations on how to dispose of your old display from your local Philips dealer.

#### (For customers in Canada and U.S.A.)

This product may contain lead and/or mercury. Dispose of in accordance to local-state and federal regulations. For additional information on recycling contact [www.eia.org](http://www.eia.org) (Consumer Education Initiative)

### Waste Electrical and Electronic Equipment-WEEE

#### Attention users in European Union private households



This marking on the product or on its packaging illustrates that, under European Directive 2012/19/EU governing used electrical and electronic appliances, this product may not be disposed of with normal household waste. You are responsible for disposal of this equipment through a designated waste electrical and electronic equipment collection. To determine the locations for dropping off such waste electrical and electronic, contact your local government office, the waste disposal organization that serves your household or the store at which you purchased the product.



### Attention users in United States:

Please dispose of according to all Local, State and Federal Laws. For the disposal or recycling information, contact: [www.mygreenelectronics.com](http://www.mygreenelectronics.com) or [www.eiae.org](http://www.eiae.org).

### End of Life Directives-Recycling



Your new Public Information Display contains several materials that can be recycled for new users.

Please dispose of according to all Local, State, and Federal laws.

### Restriction on Hazardous Substances statement (India)

This product complies with the “E-Waste (Management) Rules, 2016” CHAPTER V, rule 16, sub-rule (1) . Whereas New Electrical and Electronic Equipment and their components or consumables or parts or spares do not contain Lead, Mercury, Cadmium, Hexavalent Chromium, polybrominated biphenyls and polybrominated diphenyl ethers beyond a maximum concentration value of 0.1% by weight in homogenous materials for lead, mercury, hexavalent chromium, polybrominated biphenyls and polybrominated diphenyl ethers and of 0.01% by weight in homogenous materials for cadmium. except of exemptions set in Schedule 2 of the Rule.

### E-Waste Declaration for India

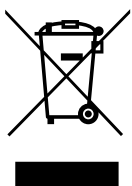

This symbol on the product or on its packaging indicates that this product must not be disposed of with your other household waste. Instead it is your responsibility to dispose of your waste equipment by handing it over to a designated collection point for the recycling of waste electrical and electronic equipment . The separate collection and recycling of your waste equipment at the time of disposal will help to conserve natural resources and ensure that it is recycled in a manner that protects human health and the environment. For more information about E -waste please visit <http://www.india.philips.com/about/sustainability/recycling/index.page> and to know where you can drop off your waste equipment for recycling in India please contact on below given contact details.

Helpline number: 1800-425-6396 (Monday to Saturday, 9 a.m. to 5:30 pm)

E-mail: [india.callcentre@tpv-tech.com](mailto:india.callcentre@tpv-tech.com)

### Batteries



For EU: The crossed-out wheeled bin implies that used batteries should not be put to the general household waste! There is a separate collection system for used batteries, to allow proper treatment and recycling in accordance with legislation.

Please contact your local authority for details on the collection and recycling schemes.

For Switzerland: The used battery is to be returned to the selling point.

For other non-EU countries: Please contact your local authority for correct method of disposal of the used battery.

According to EU directive 2006/66/EC, the battery can't be disposed improperly. The battery shall be separated to collect by local service.

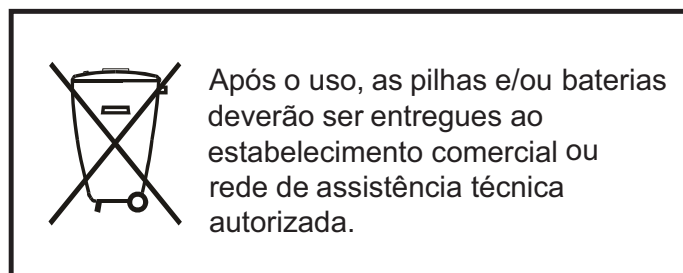

|                                   |  |
|-----------------------------------|--|
| Information for EAC               |   |
| Month and year of manufacturing   | please refer information in Rating label.  |
| Name and location of manufacturer | ООО "Профтехника"<br>Адрес: 3-й Проезд Марьиной роши, 40/1 офис 1. Москва, 127018, Россия  |
| Importer and information          | Наименование организации: ООО "Профтехника"<br>Адрес: 3-й Проезд Марьиной роши, 40/1 офис 1. Москва, 127018, Россия<br>Контактное лицо: Наталья Астафьева,<br>+7 495 640 20 20<br><a href="mailto:nat@profdisplays.ru">nat@profdisplays.ru</a> |

## Cleaning

If the LED display/cabinet becomes dusty, use an air blower which can produce air flow to blow away dust.

Cautions when cleaning the display:

⚠ Do not use a wet cloth to clean the LED display.

⚠ Do not allow water or other liquid to enter the LED display.

⚠ Do not use tool that generate large amount of static electricity, such as a bristle brush.

The front of the LED display has been specially treated. Do not touch the surface of the LED display with fingernails or any hard object, otherwise the LED elements may fall off.

## Storage

If you are not going to use it for an extensive period of time, unplug the display and keep the product in a dry and well-ventilated location.

# Table Of Contents

|      |  |    |
|------|--|----|
| 1.   | Preparations.....                                    | 1  |
| 1.1. | Unpacking.....                                       | 1  |
| 1.2. | Package Contents .....                               | 1  |
| 1.3. | Holding the cabinet .....                            | 2  |
| 1.4. | Installation Notes.....                              | 2  |
| 2.   | Product overview .....                               | 3  |
| 2.1. | Front view.....                                      | 3  |
| 2.2. | Rear view .....                                      | 3  |
| 2.3. | Side view.....                                       | 3  |
| 2.4. | Top view.....  | 3  |
| 2.5. | Bottom view.....                                     | 3  |
| 3.   | Preparation.....                                     | 4  |
| 3.1. | Testing the cabinet.....                             | 4  |
| 3.2. | Removing the opening .....                           | 4  |
| 4.   | Installation.....                                    | 5  |
| 5.   | Connection.....                                      | 8  |
| 5.1. | Connecting the signal and power cables...8           |    |
| 5.2. | Mounting scheme .....                                | 9  |
| 6.   | Installing the modules .....                         | 10 |
| 7.   | Dehumidification function .....                      | 12 |
| 7.1. | Installing the program.....                          | 12 |
| 7.2. | Firmware upgrade and verification.....               | 12 |
| 7.3. | Configuring dehumidification settings .....          | 17 |
| 7.4. | Activating Dehumidification function.....            | 19 |
| 7.5. | Cancelling Dehumidification function.....            | 19 |
| 7.6. | Notes .....  | 19 |
| 8.   | Using the LED display controller .....               | 20 |
| 9.   | Warranty Statement .....                             | 20 |
|      | Appendices .....                                     | 21 |
|      | Appendix A. Troubleshooting .....                    | 21 |
|      | Appendix B. Dew point VS. Relative Humidity...22     |    |
|      | Appendix C. Optional Components/<br>Accessories..... | 23 |
|      | Appendix D. Technical Specifications .....           | 26 |
|      | Appendix E. Power/Data cable measure .....           | 28 |
|      | Appendix F. Mounting scheme.....                     | 32 |

# 1. Preparations

## 1.1. Unpacking

### ⚠ Warning:

To prevent damage to the LED panel, wear anti-static gloves before installing/touching the display. After unpacking, do not place the display vertically on the floor, an accident such as fall may be caused.

1. Use a pair of scissors to cut sealing tape on the cardboard box.
2. Carefully take the cabinet and accessories out of the cardboard box.
3. After opening the cardboard box, ensure that the contents are complete and in good condition.

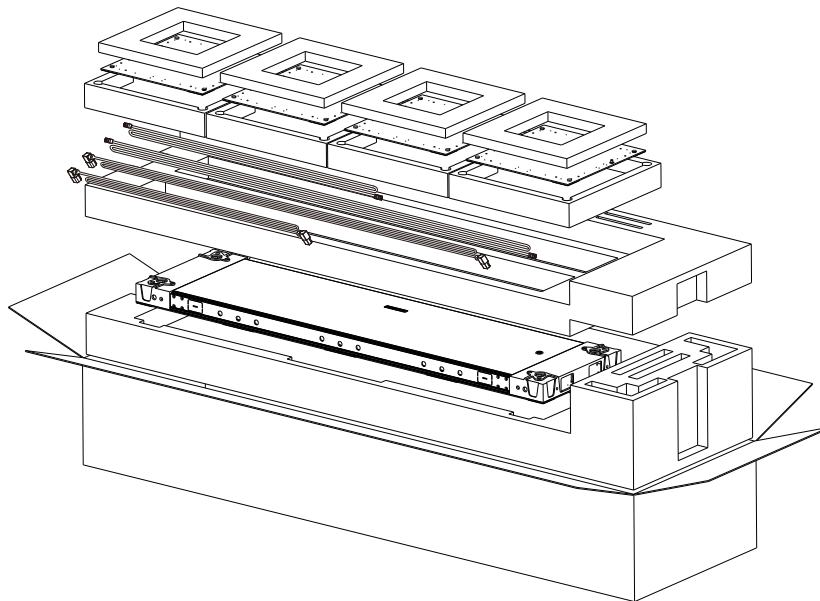

## 1.2. Package Contents

Please verify that you received the following items with your package content:

- LED cabinet x1
- Quick start guide x1
- Power cable (daisy chain) x2
- LAN cable (RJ45, CAT-5) x2

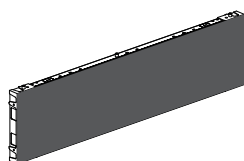

LED cabinet



Quick start guide

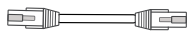

LAN cable  
(RJ45, CAT-5)

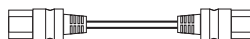

Power cable  
(daisy chain)

\* Display design and accessories may differ from those illustrated above.

### NOTES:

- For all other regions, apply a power cord that conforms to the AC voltage of the power socket and has been approved by and complies with the safety regulations of the particular country.
- You might like to save the package box and packing material for shipping the display.

### 1.3. Holding the cabinet

**⚠ Warning:**

To prevent damage to the LED, do NOT touch the edge of each LED module when holding the cabinet by hand. Refer to the illustration below for the recommended manner of holding a cabinet.

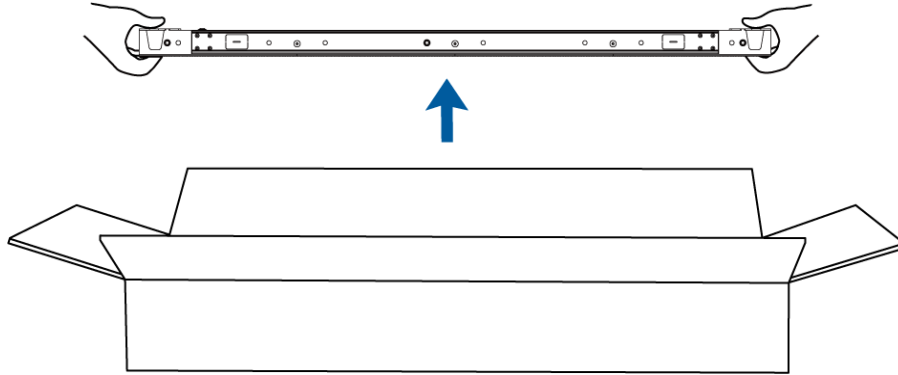

### 1.4. Installation Notes

- Only use the power cable provided with this product. If an extension cord is required, please consult your service agent.
- The product should be installed on a flat surface, or the product may tip over. Leave a space between the rear of the product and the wall for proper ventilation. Do not install the product in a kitchen, bathroom or a place exposed to moisture, failure to do so may shorten the life of the internal parts.
- Do not install the product where it is 5000m and higher in altitude. Failure to do so may result in malfunctions.

## 2. Product overview

### 2.1. Front view

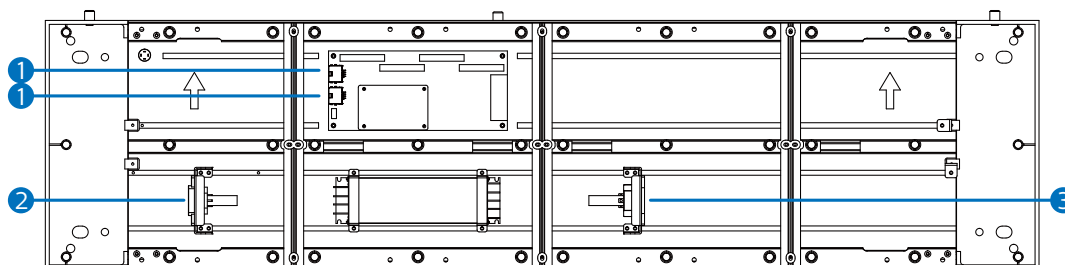

### 2.2. Rear view

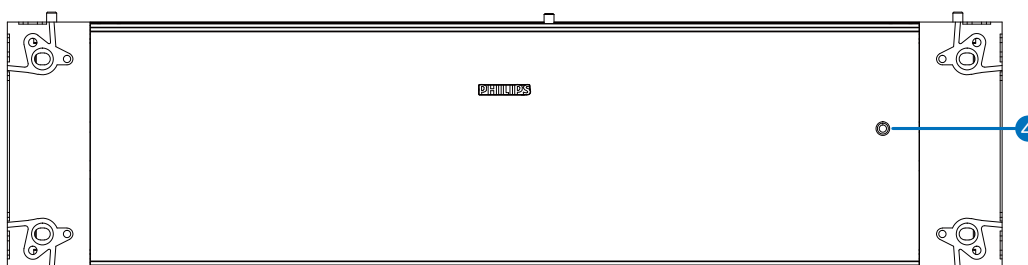

### 2.3. Side view

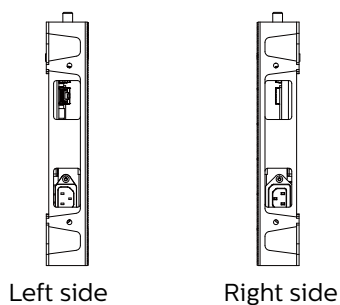

### 2.4. Top view



### 2.5. Bottom view



| No. | Component          | No. | Component           |
|-----|--------------------|-----|---------------------|
| 1   | Data connector (s) | 3   | Power Out connector |
| 2   | Power In connector | 4   | CHECK button        |

⚠ The Data connector (1) is an RJ45 connector, but it cannot be connected with a network switch or common computer networking device as it is not compatible.

### 3. Preparation

#### 3.1. Testing the cabinet

1. Power on the product by connecting the power cable from the cabinet to the power outlet.
2. Press the **CHECK** button on the back of each cabinet to check if the product can operate normally.
3. Check whether each color is displayed normally on the screen from the front side of the display.

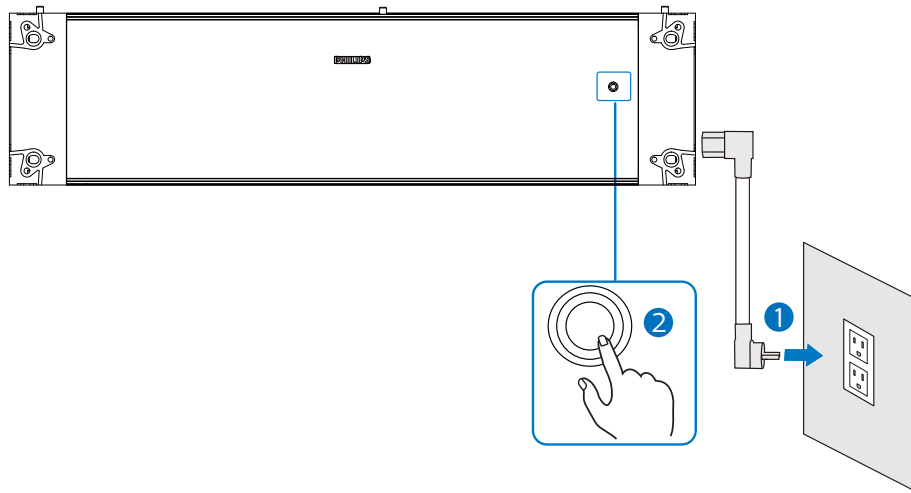

🔧 To test the cabinet, a power cable that connects from the cabinet to the power outlet is required (but not provided).

#### 3.2. Removing the opening

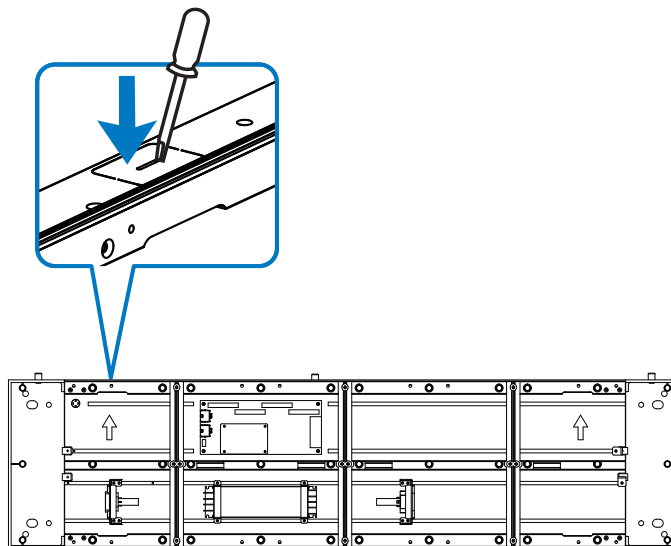

🔧 Before breaking the opening, determine the number of displays to install and the installation layout to form a large video wall array.

## 4. Installation

⚠ Precautions when handling the cabinets:

- Do not drop or apply shock/vibration to the product. Strong impacts may damage the component inside.
- Only a qualified service technician should perform installation.
- Only use approved cabinets.
- Be careful not to damage the corners of the cabinet.
- Install the display in a well-ventilated area.
- After removing the protective brackets, do not place the display with the LED facing down, the LED display may become damaged.
- Always wear anti-static gloves when touching the display.
- Provide air conditioning around the LED display to allow heat dissipation away from the display.
- To maintain proper ventilation, keep clear space from the mounted displays to the wall. (Refer to the diagram below for the recommended distance between the LED display and wall). Installing the product in poorly ventilated spaces may damage the LED.

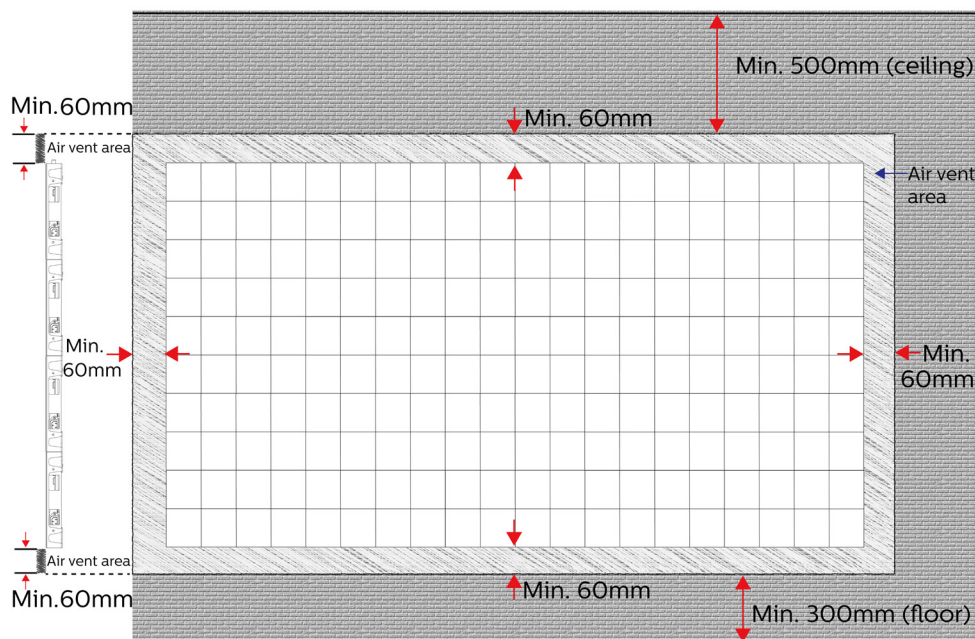

A wall mount kit (in some regions sold separately or available from third party vendors) allows you to mount the LED display on the wall. For detailed information on installing the wall mount, see the instructions provided with the wall mount. Wall mounting can only be performed from the front side of cabinets.

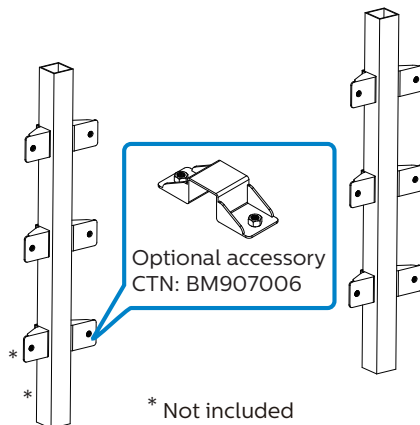

🔧 The mounting interface should be strong enough to bear the weight of the display. Ensure that your wall mount bracket has the mounting holes accurately drilled at proper position.



## Step 1.

Insert the connecting plate with screw bolt into the mounting hole on the bracket. Rotate the hex key clockwise until the screw bolt is firmly fastened.

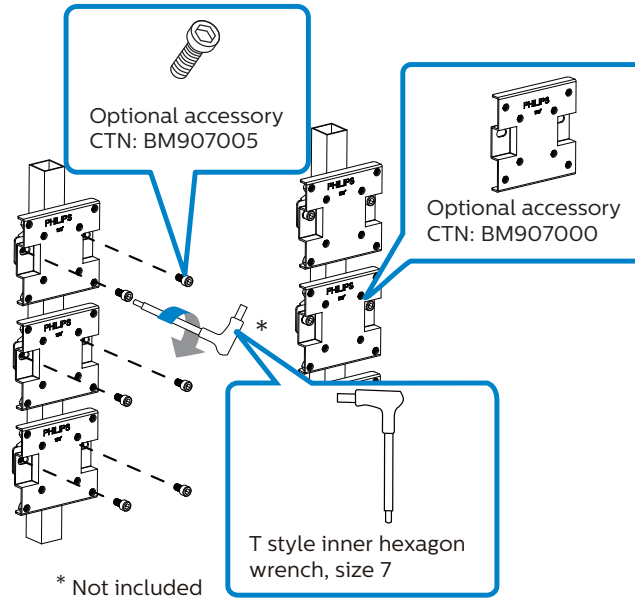

ⓘ Ensure that the "Philips" wordmark on the connecting plate is facing the cabinet.

## Step 2.

Align the cabinet with the connecting plate and secure the cabinet to the holes on the connecting plate. Rotate the hex key clockwise until the screw bolt is firmly fastened.

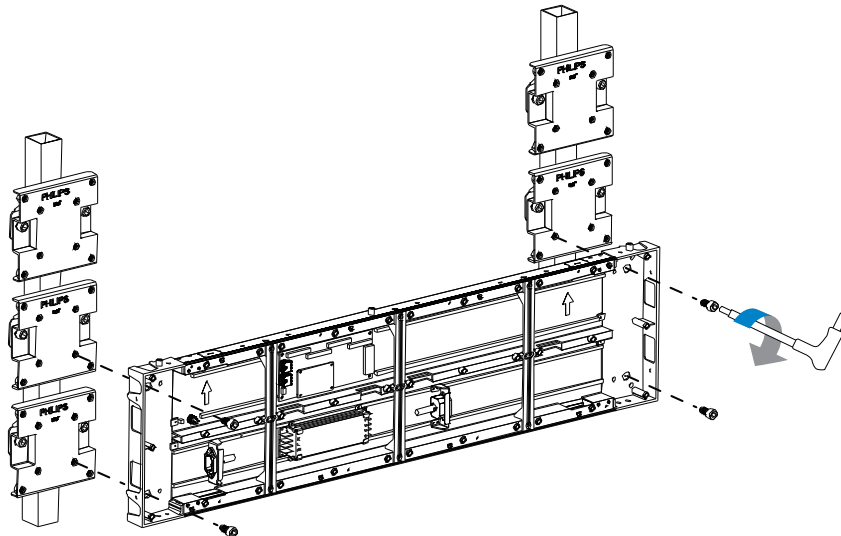

**Step 3.**

Repeat step 2 until all cabinets are mounted onto the bracket.

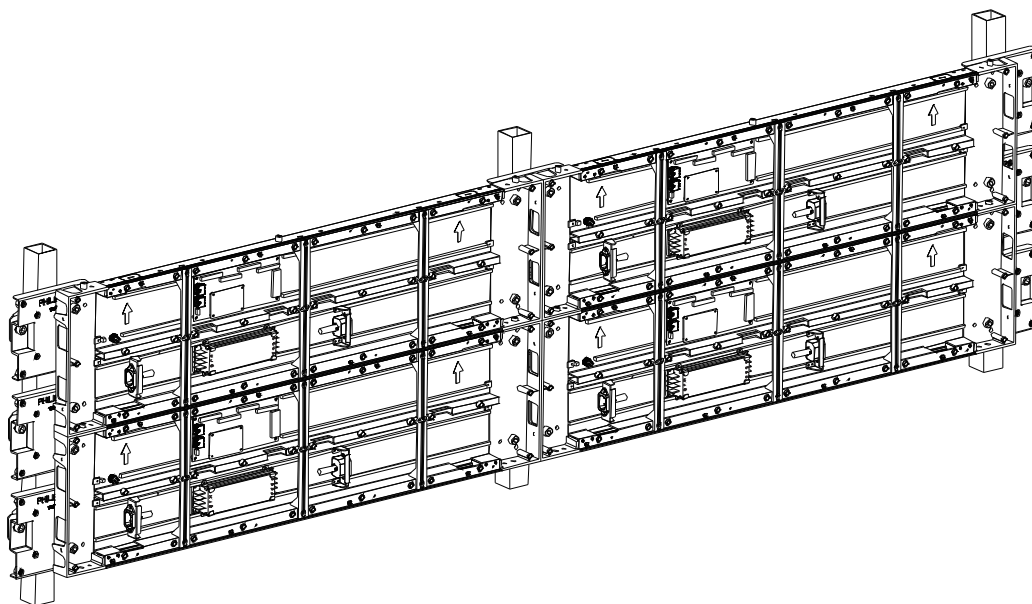

## 5. Connection

### 5.1. Connecting the signal and power cables

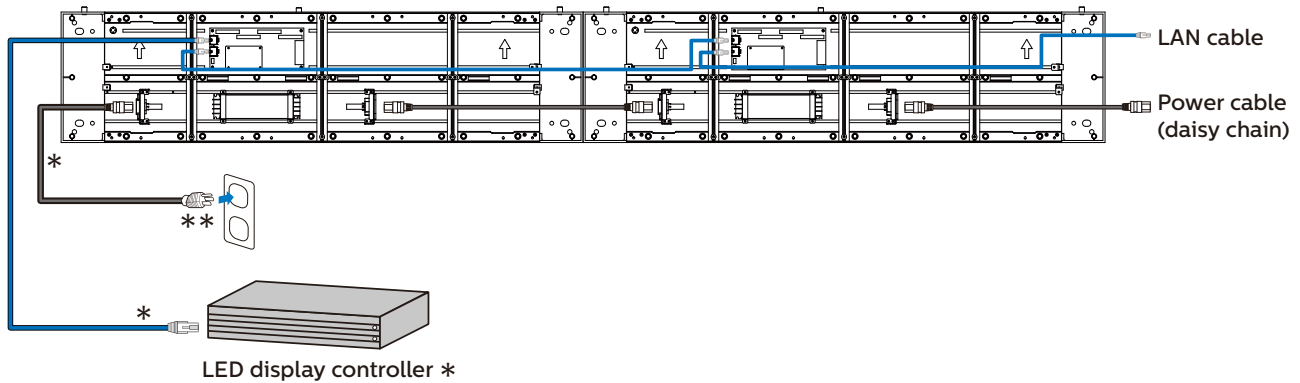

\* Optional accessories

\*\* Power plug types vary by country/region.

#### ⚠ Cautions

Connection is allowed up to 4 cabinets when the 110 VAC power supply is used.

Connection is allowed up to 8 cabinets when the 220 VAC power supply is used.

**Max. daisy chain cable current rating: 10 Amp** (please take this into account when you combine different cabinets)

Turn off the power of all devices first before connecting cables.

1. Connect the power cable from the “**Power Out**” port of the first cabinet to the “**Power In**” port of the second cabinet.
2. Connect the signal cable from the Data port of the first cabinet to Data port of the second cabinet for video signal transmission. Connect the power cable from the “**Power In**” port of the first cabinet to the power outlet.
3. Connect one end of the data cable of the first cabinet to the LED display controller.
4. Repeating steps 2-3 enables the daisy chain connection.

#### ⚠ Caution

Plug the power plug into the electric outlet only when the cables are properly wired.

#### 🔧 Notes:

1. In some larger installations, you may need to do the wiring for RJ45 and power cables via the backside where opening is unavailable. In such situation this can be solved by using 1 cabinet with 45 degree corner cut (73xx series) to have an opening towards the backside for cables/wiring.
2. For further details on the length of power/data cable required for installation, refer to Appendix E. Power/Data cable measure.

## 5.2. Mounting scheme

The variety of cabinet sizes and layout configurations allows you to build any LED video wall array as needed.

Before mounting, determine the number and size of displays to install, then identify the alignment pins on the top of the cabinets. As the position of the alignment pin differs by models, you may need to adjust the alignment pin if necessary.

To make such adjustment, use a hexagon wrench (not provided) to remove the alignment pin and insert it into the new alignment screw thread hole.

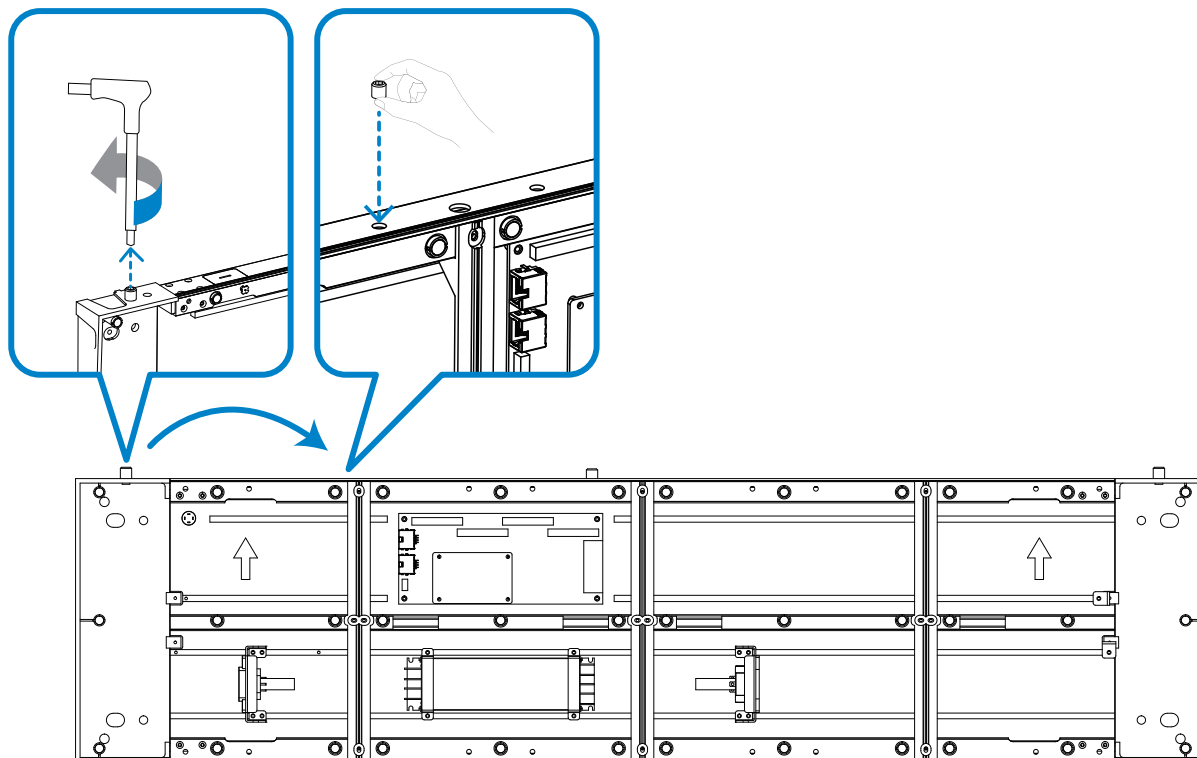

### Notes:

1. The tool used in this step is Inner hexagon wrench, size 4.
2. For further details on the mounting scheme, refer to Appendix F. Mounting scheme.

## 6. Installing the modules

When installing the modules, refer to the instruction and installation order specified below. Note that screen output may not be displayed properly if instructions are not followed.

Every cabinet has a serial number supplied and this serial number is located on the label that is affixed to the interior of the cabinet. Whereas one label can be found inside each module indicating the serial number of the module. This label provides important information to uniquely identify every single module, as it allows you to easily locate the correct module that connects to the cabinet. When installing the module onto the cabinet, make sure the serial number on the module label matches that of the cabinet label.

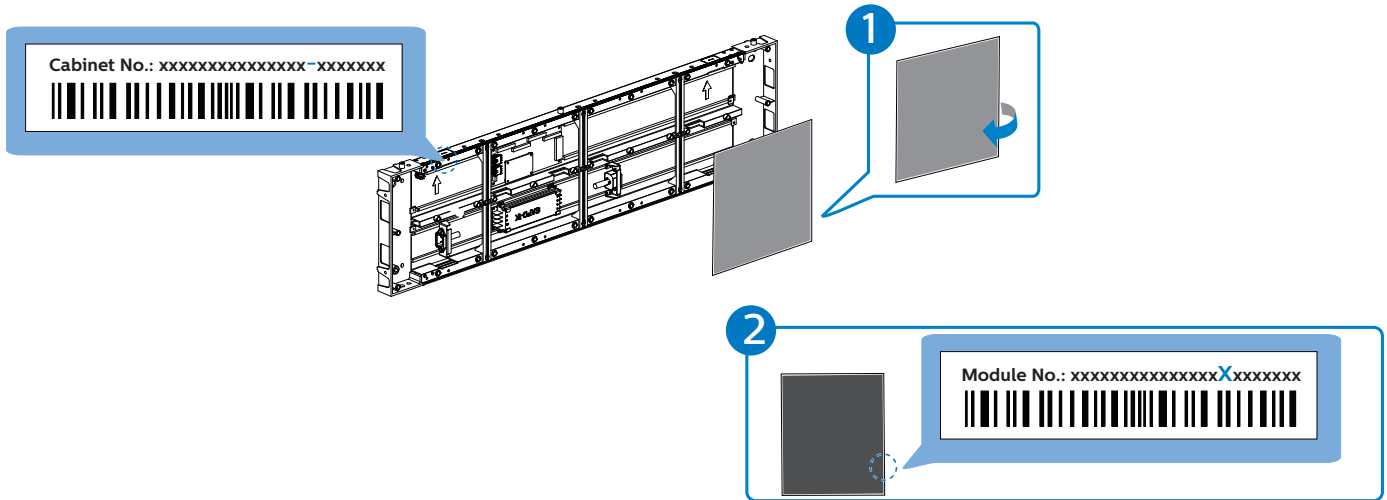

The 16th digit of the serial number corresponds to the position code of the module. Follow the ascending alphabetical order to install the module to correct position. Refer to the diagram **2** below on the proper order of installing the modules.

To install the module to the hub board, the flat cable that connects between them has to be properly wired. One end of the flat cable is already attached to the hub board, use the other end to connect it to the module. Before connection, make sure that the arrow sign on the module is pointing up. Connect the flat cable to the connector on the module until it clicks into place. To prevent reversed connection when connecting the cable, locate the star sign on the module first. Ensure that the star sign and the red stripe on the cable match up (refer to the diagram **3** below.)

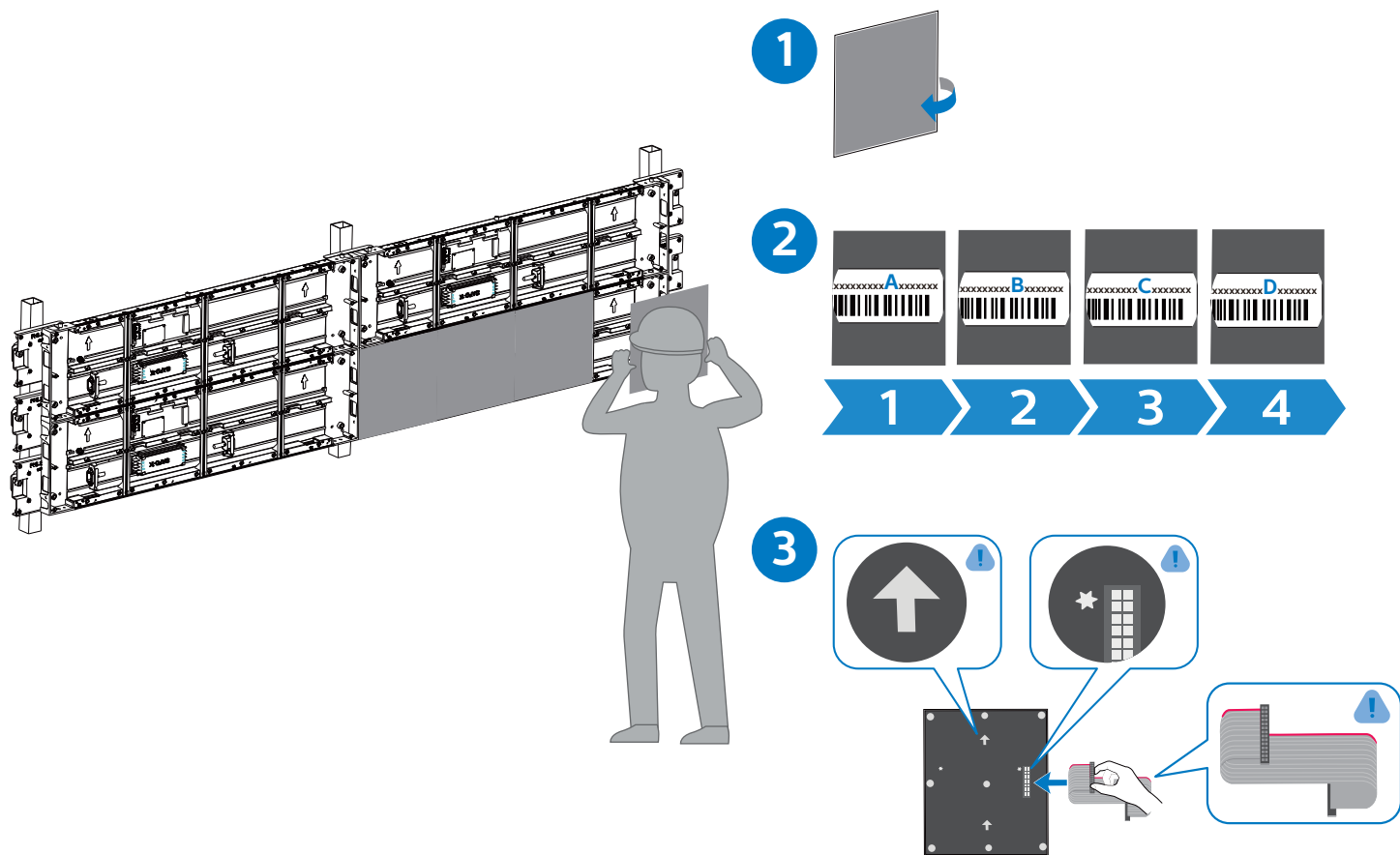

## 7. Dehumidification function

### Purpose of dehumidification in LED display

Internal parts and elements tend to corrode during storage when the LED display is left unused for a long period of time in a humid environment. In particular when moisture gets into the diode, it may cause blurred screen or defective LED. As a result, the dehumidification has an important role to play in the performance and lifespan of LED display.

### Principles of dehumidification

Configuring LED display controller settings allows the display to change the brightness level from low to high during boot up process. Likewise, the heat generated in the fade up process can take moisture out of the LED display. A stepwise fade up process can avoid impulse current caused by damp diode when booting up the display.

### 7.1. Installing the program

Dehumidification function is a custom-built procedure designed for use with specific LED display controller firmware.

1. Get the program “NovaLCT V5.3.1 Plus” from your local distributor and download it to your computer.
2. Install the program “NovaLCT V5.3.1 Plus”.
3. Connect the USB cable to your PC and run “NovaLCT V5.3.1 Plus” that you installed.

### 7.2. Firmware upgrade and verification

Select the User tab.

1. Select **Advanced Synchronous System User Login(A)**. See Figure 1-1.

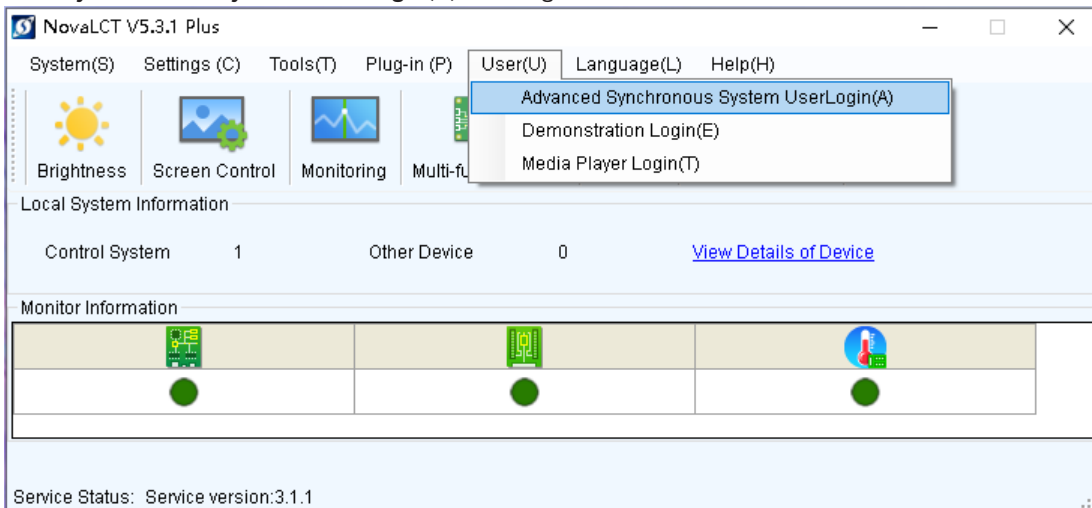

Figure 1-1

2. Enter the password and click **Login**. The default password is **admin** or **666**. See Figure 1-2.

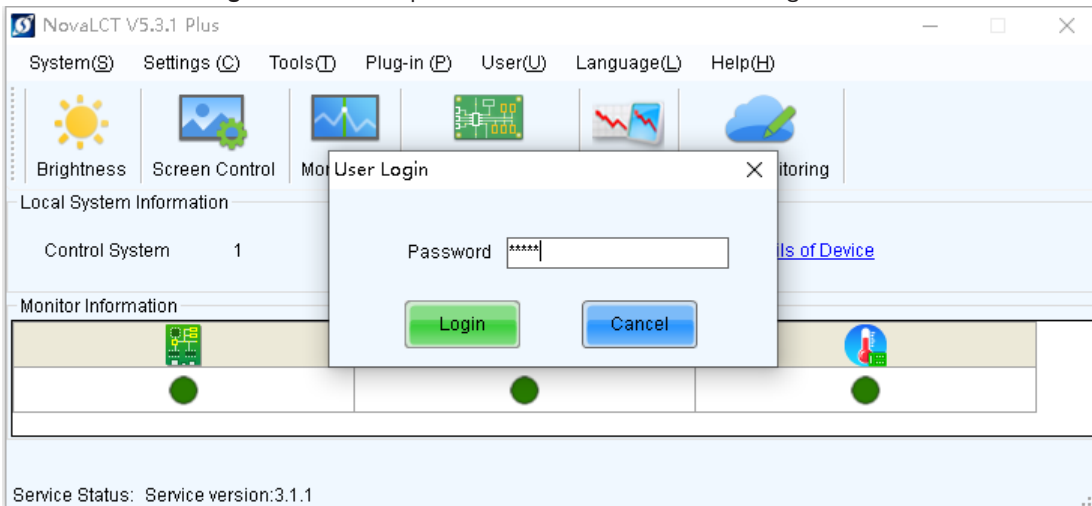

Figure 1-2

3. Enter the password **admin** or **666888** in the main menu. See Figure 1-3.

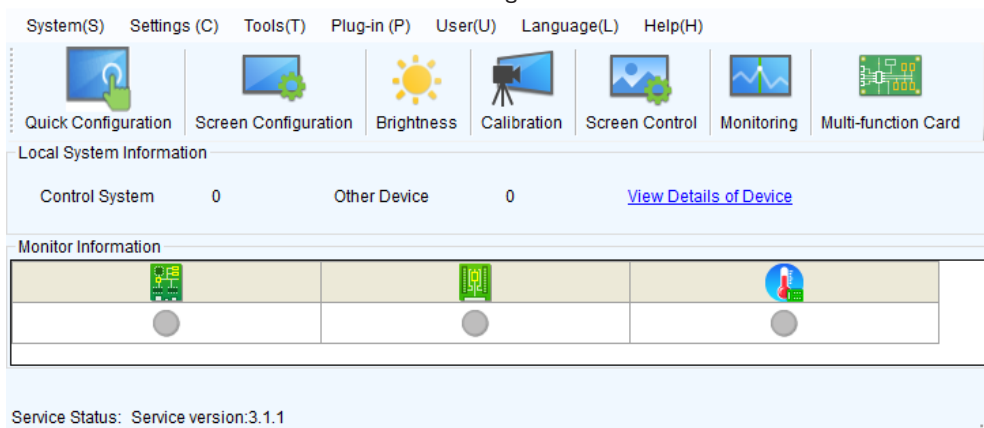

Figure 1-3

4. A dialog box will then appear as shown in Figure 1-4. Select the **Communication port** for operation. Click **Reconnect** if you need to reconnect the LED display controller.

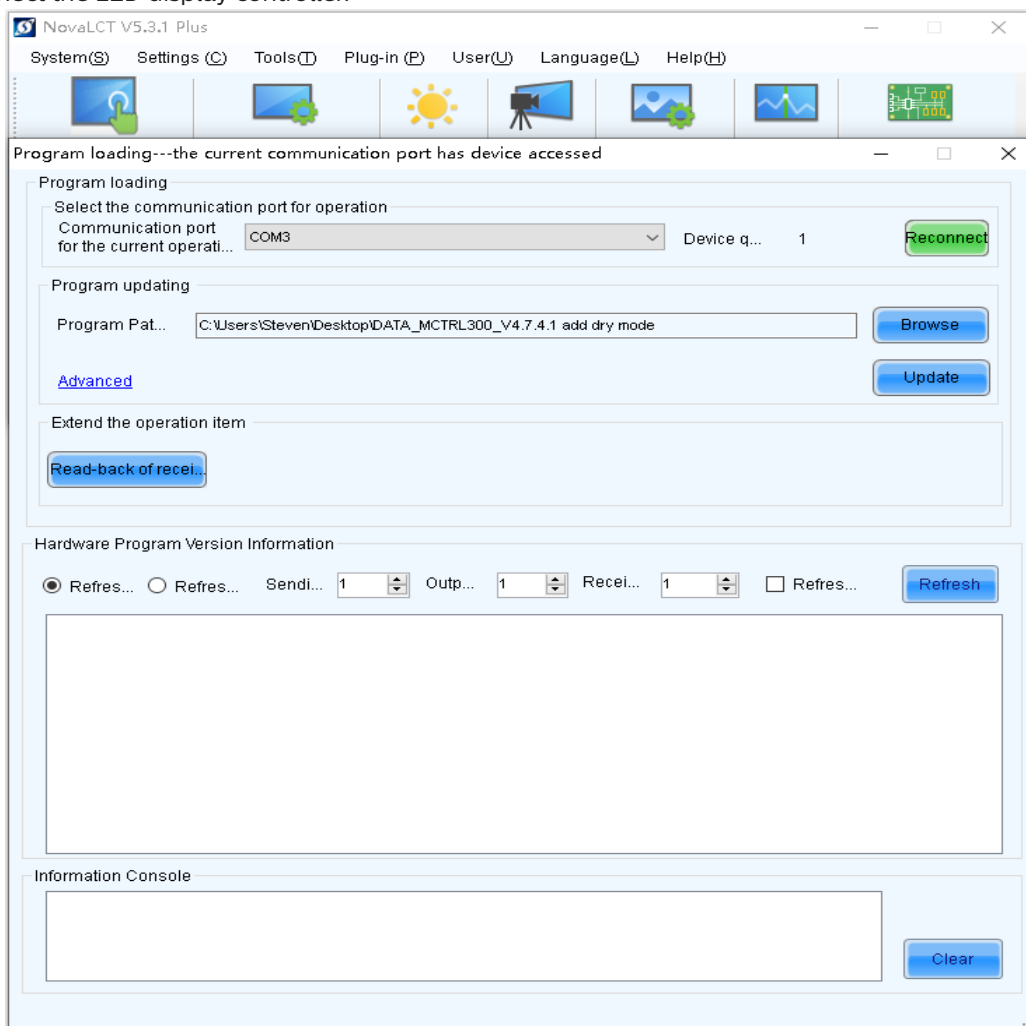

Figure 1-4



5. Inform your supplier the model of the LED display controller you are using, a corresponding firmware will then be provided to you. Click **Browse** to search the firmware file provided by your supplier. See Figure 1-5.

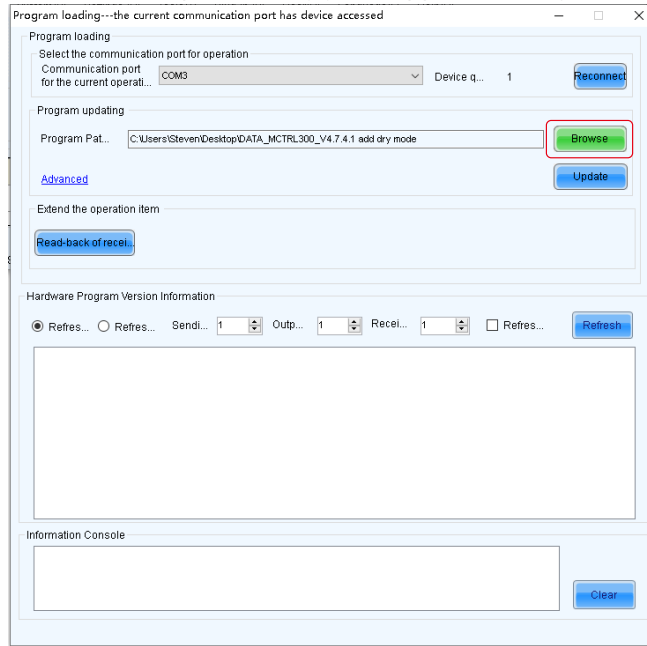

Figure 1-5

6. Click **Update** to start updating. See Figure 1-6.

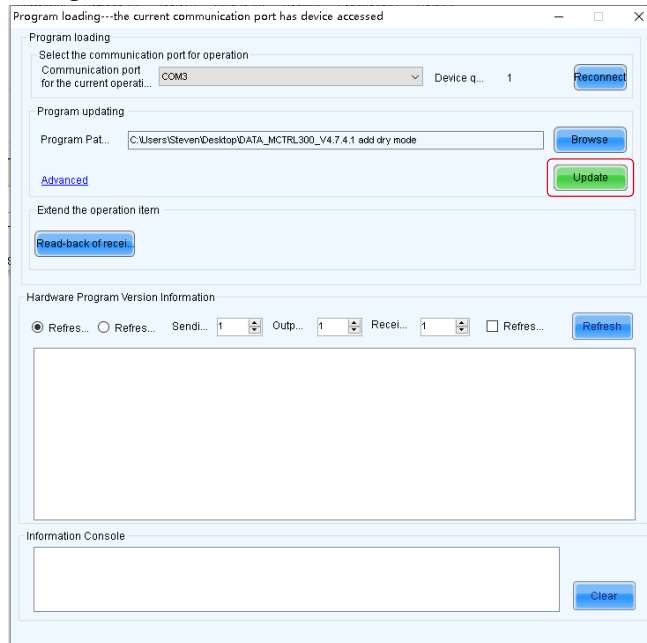

Figure 1-6

7. After the update is complete, click OK. See Figure 1-7.

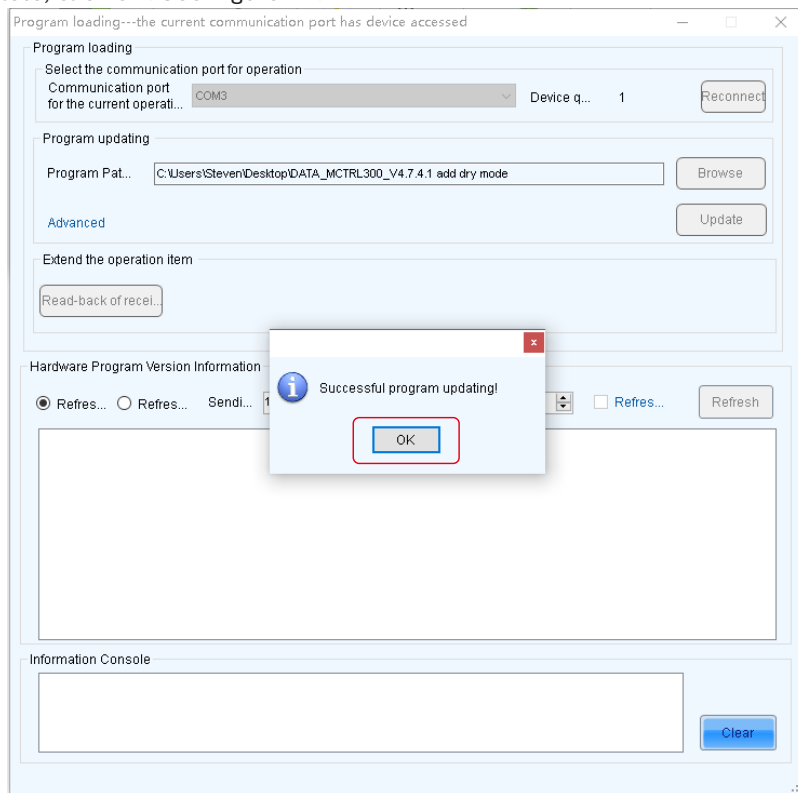

Figure 1-7

## 8. Verification

In **hardware program version information**, click **Refresh** (default value is Refresh All). Verification process starts by checking the version numbers between the LED display controller and the one with dehumidification. If the version numbers are consistent, it indicates that firmware upgrade is successful. See Figure 1-8.

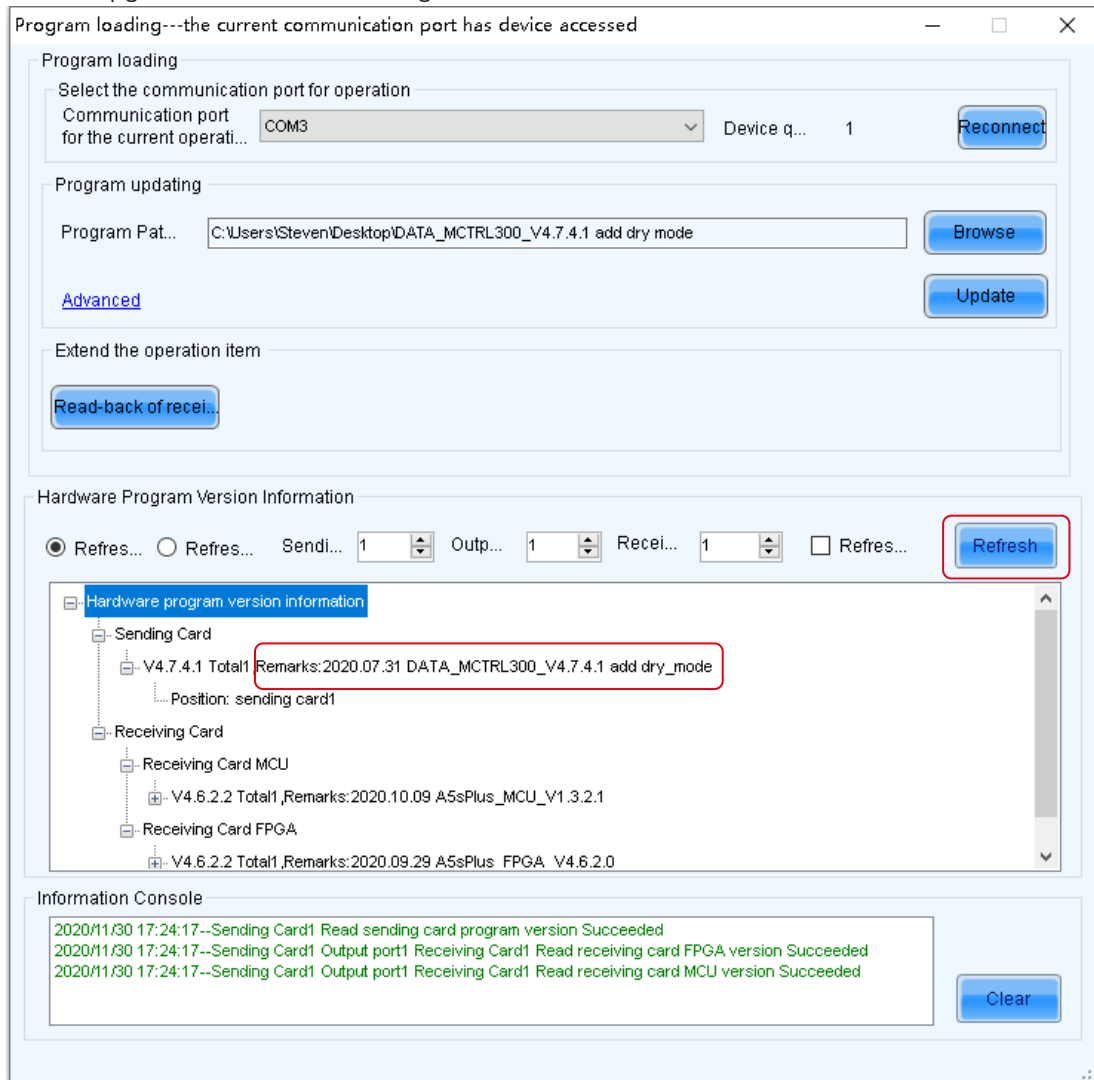

Figure 1-8

### 7.3. Configuring dehumidification settings

When the LED display is operated normally over a period of time, follow the steps below before you turn the display off:

1. Run the program **NovaLCT V5.3.1 Plus**.
2. After screen configuration is complete, click **Brightness**. See Figure 2-1.

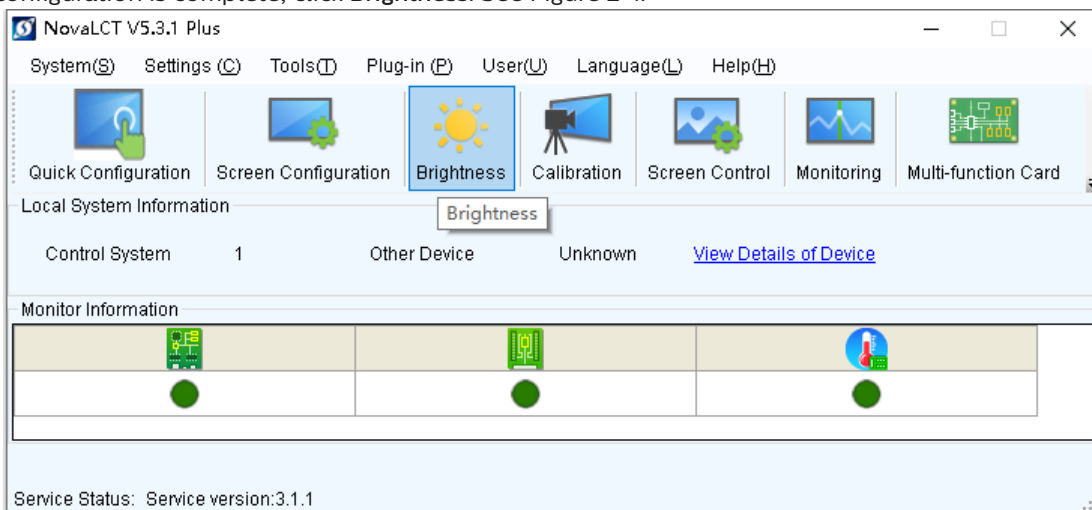

Figure 2-1

3. In brightness adjustment screen, click the **Enable Dry mode** checkbox. See Figure 2-2.

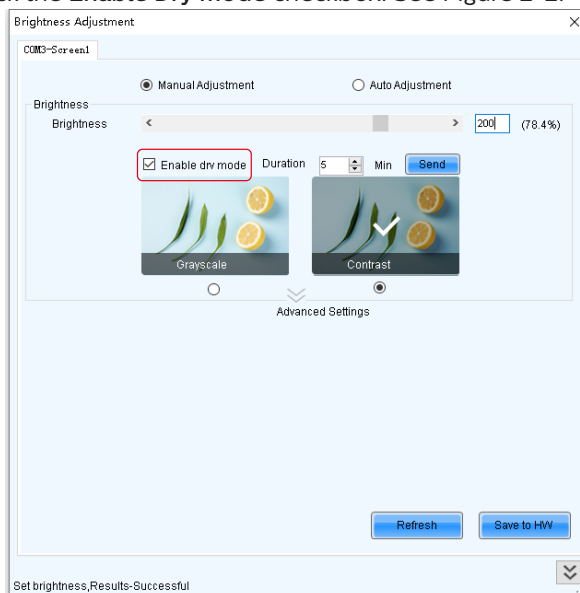

Figure 2-2

4. Set dehumidification time in the **Duration** field. Refer to **Table 1** for suggested dehumidification duration.

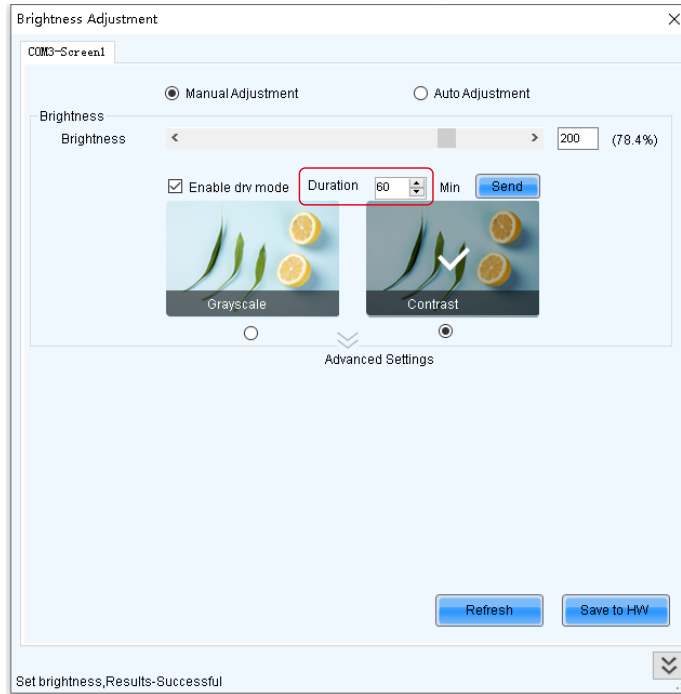

Figure 2-3

5. Click **Send** and **Save to HW**, then check that brightness is set successfully in the information box at the bottom of the screen.

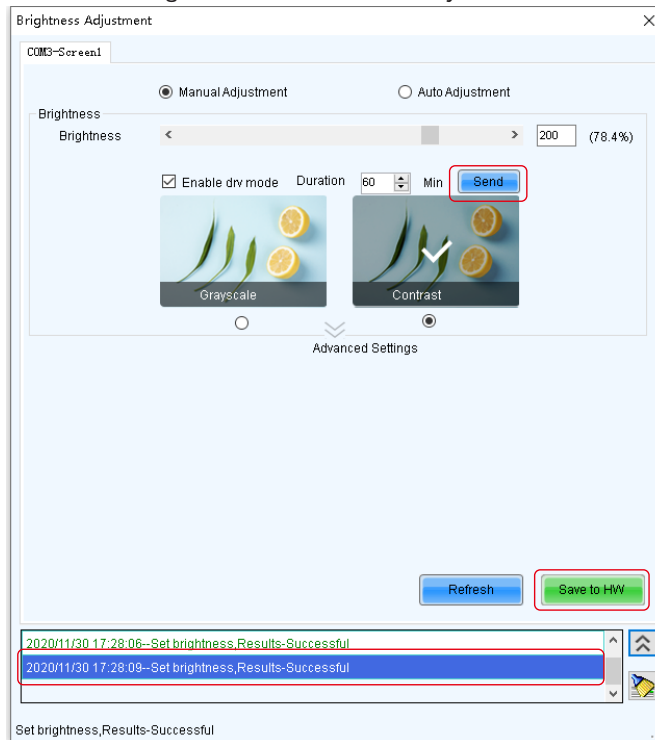

Figure 2-4

6. To make sure the dehumidification function is initiated, wait 1 minute before you exit the brightness setting menu.

## 7.4. Activating Dehumidification function

1. Turn off the LED display and power off the LED display controller.
2. When using the LED display, turn on the LED display controller and the LED display.

\* You can notice that, according to the dehumidification time you set, the brightness of your LED display changes from dark to bright gradually. When the highest brightness level is reached, the brightness returns to the default value defined by user automatically.

3. Whenever you turn on the LED display, the dehumidification function starts working automatically after the LED display controller is activated.

## 7.5. Cancelling Dehumidification function

1. In the brightness adjustment screen, deselect the **Enable Dry mode** checkbox.
2. Click **Send** and **Save to HW**.
3. After setting is complete, the dehumidification function must be disabled. Whether the LED display is under normal operation or during execution of dehumidification, the dehumidification function can always be cancelled with immediate effect regardless of its current status.

## 7.6. Notes

1. Dehumidification function has to be used with specific LED display controller program. If your LED display shows that the LED display controller you are using has not been upgraded with corresponding program, please contact us for support.
2. The maximum value you can set for dehumidification duration is 240 minutes, while the minimum value allowed is 5 minutes.
3. The principles of duration and brightness enhancement:
4. Based on the duration set by user, it will be divided into 15 proportional levels automatically. The display brightness will also be divided into 15 levels ranging from level 0 for a black screen to level 255 for a brighter screen. As duration level increases, brightness level will be adjusted to fit the duration level.
5. For example, when **Duration** is set to 150 min, then brightness changes every 10 minutes, brightness level changes 256/15 every time, meaning that brightness level increases by 17% every 10 minutes.
6. Referring to the dehumidification principle, it is suggested to set the dehumidification time based on the data listed below. You can also adjust the dehumidification time in accordance with your actual situation.

|   | Consecutive day(s) left<br>unused | Duration/min |              |
|---|-----------------------------------|--------------|--------------|
|   |                                   | Humidity<40% | Humidity≥40% |
| 1 | Day < 1                           | 0            | 15           |
| 2 | $1 \leq \text{Day} < 3$           | 15           | 120          |
| 3 | $3 \leq \text{Day} < 7$           | 120          | 240          |
| 4 | Day $\geq 7$                      | 240          | 240          |

Table 1 Suggested dehumidification duration

7. Dehumidification is not a must function of the LED display, but it is indeed a desirable option as it can reduce problems associated with the presence of humidity such as low performance and shortened lifespan. In most cases, dehumidification can be cancelled and only be used when necessary.

## 8. Using the LED display controller

The LED display controller is a device served for managing any type of video and data sources for any screen configuration. Visit Novastar website to learn more about Novastar's LED display controller and select the one that suit your needs according to the resolution and screen configuration of your display.

<https://www.novastar.tech/products/>

To download the Novastar software and user's guide, click on the following link:

<https://www.novastar.tech/downloads/controller/>

## 9. Warranty Statement

Warranty period for PHILIPS signage display is listed as below, for areas not covered in this table, please follow their warranty statement.

| Region       | Warranty Period |
|--------------|-----------------|
| USA, Canada  | 2 years         |
| China        | 1 year          |
| Asia Pacific | 2 years         |
| Europe       | 2 years         |
| Brazil       | 2 years         |

## Appendices

### Appendix A. Troubleshooting

Frequently asked questions and common problems that may occur while using the system are explained in this section. Observe the following table containing a list of symptoms and the actions to take to solve the problems.

If a problem persists after performing the following actions, contact technical support.

| Symptom                    | Possible cause and corrective action   |
|----------------------------|--|
| No picture is displayed    | <ul style="list-style-type: none"> <li>• The power cable is disconnected.<br/>&gt; Re-connect the power cable.</li> <li>• The signal cable is disconnected.<br/>&gt; Re-connect the signal cable.</li> <li>• The main switch on the power distribution box is off.<br/>&gt; Make sure the power distribution box is switched on.</li> <li>• The LED display controller is off.<br/>&gt; Inspect whether the power connection is correct and the switch has been turned on.<br/>&gt; Inspect whether the LED display controller output has signal and shows blank screen.<br/>&gt; Check whether the mode and parameter of screen configuration are correct.<br/>&gt; Check whether there is image input in input channel and whether it is correctly displayed.</li> </ul> |
| The module is blinking     | > Check the cable connection between the cabinet and power distribution box, and ensure the connection is secure.  |
| The module cannot light up | > Check the cable connection between the cabinet and power distribution box, and ensure the connection is secure.  |



## Appendix B. Dew point VS. Relative Humidity

The table below explains the relationship between temperature/relative humidity and dew point.

|                       |        |        |        |        |        |        |        |        |
|-----------------------|--------|--------|--------|--------|--------|--------|--------|--------|
| Celsius (° C)         | -20    | -20    | -20    | -20    | -20    | -20    | -20    | -20    |
| Relative Humidity (%) | 10     | 20     | 30     | 40     | 50     | 60     | 70     | 80     |
| Dew point (° C)       | -43.87 | -37.24 | -33.15 | -30.15 | -27.76 | -25.77 | -24.06 | -22.56 |
| Celsius (° C)         | -10    | -10    | -10    | -10    | -10    | -10    | -10    | -10    |
| Relative Humidity (%) | 10     | 20     | 30     | 40     | 50     | 60     | 70     | 80     |
| Dew point (° C)       | -35.94 | -28.76 | -24.32 | -21.06 | -18.46 | -16.30 | -14.43 | -12.79 |
| Celsius (° C)         | 0      | 0      | 0      | 0      | 0      | 0      | 0      | 0      |
| Relative Humidity (%) | 10     | 20     | 30     | 40     | 50     | 60     | 70     | 80     |
| Dew point (° C)       | -28.08 | -20.33 | -15.54 | -12.01 | -9.19  | -6.84  | -4.82  | -3.03  |
| Celsius (° C)         | 10     | 10     | 10     | 10     | 10     | 10     | 10     | 10     |
| Relative Humidity (%) | 10     | 20     | 30     | 40     | 50     | 60     | 70     | 80     |
| Dew point (° C)       | -20.29 | -11.96 | -6.80  | -2.99  | 0.04   | 2.58   | 4.77   | 6.70   |
| Celsius (° C)         | 25     | 25     | 25     | 25     | 25     | 25     | 25     | 25     |
| Relative Humidity (%) | 10     | 20     | 30     | 40     | 50     | 60     | 70     | 80     |
| Dew point (° C)       | -8.75  | 0.47   | 6.22   | 10.46  | 13.85  | 16.69  | 19.14  | 21.30  |
| Celsius (° C)         | 35     | 35     | 35     | 35     | 35     | 35     | 35     | 35     |
| Relative Humidity (%) | 10     | 20     | 30     | 40     | 50     | 60     | 70     | 80     |
| Dew point (° C)       | -1.15  | 8.7    | 14.84  | 19.39  | 23.02  | 26.07  | 28.70  | 31.03  |
| Celsius (° C)         | 45     | 45     | 45     | 45     | 45     | 45     | 45     | 45     |
| Relative Humidity (%) | 10     | 20     | 30     | 40     | 50     | 60     | 70     | 80     |
| Dew point (° C)       | 6.38   | 16.87  | 23.42  | 28.28  | 32.17  | 35.43  | 38.25  | 40.74  |

## Appendix C. Optional Components/Accessories

If you need to purchase the components or accessories listed below, please contact your local service center for support.

| CTN           | Commercial description                   |
|---------------|--|
| 41BDL7224L/00 | LED Display Cabinet 7224 100x25          |
| 41BDL7324L/00 | LED Display Cabinet 7324 100x25, 45 deg. |
| 31BDL7224L/00 | LED Display Cabinet 7224 75x25           |
| 31BDL7324L/00 | LED Display Cabinet 7324 75x25, 45 deg.  |
| 22BDL7224L/00 | LED Display Cabinet 7224 50x25           |
| 22BDL7324L/00 | LED Display Cabinet 7324 50*25, 45 deg.  |
| BM904172/00   | LED Display Cabinet 72xx 1000x250        |
| BM904173/00   | Empty LED Display Cabinet 73xx 100x25    |
| BM903172/00   | Empty LED Display Cabinet 72xx 75x25     |
| BM903173/00   | Empty LED Display Cabinet 73xx 75x25     |
| BM902272/00   | Empty LED Display Cabinet 72xx 50x25     |
| BM902273/00   | Empty LED Display Cabinet 73xx 50x25     |
| CRD17024/00   | LED module, 7x24-series, SMD1515 Copper  |
| CRD17031/00   | LED module, 7x31-series SMDXXXX Copper   |
| CRD17019/00   | LED module, 7x19-series, SMD1515 Copper  |
| CRD17039/00   | LED module, 7x39-series, SMDXXXX Copper  |
| CRD17124/00   | P2.4 High Brightness                     |
| CRD17131/00   | P3.1 High Brightness                     |
| CRD17139/00   | P3.9 High Brightness                     |
| CRD20001/00   | Controller Novastar MCTRL300 (EU)        |
| CRD20001/17   | Controller Novastar MCTRL300 (US)        |
| CRD20001/05   | Controller Novastar MCTRL300 (HK)        |
| CRD20001/75   | Controller Novastar MCTRL300 (CN/AUS)    |
| CRD20001/67   | Controller Novastar MCTRL600 (THAI)      |
| CRD20002/00   | Controller Novastar MCTRL600 (EU)        |
| CRD20002/17   | Controller Novastar MCTRL600 (US)        |
| CRD20002/05   | Controller Novastar MCTRL600 (HK)        |
| CRD20002/75   | Controller Novastar MCTRL600 (CN/AUS)    |
| CRD20002/67   | Controller Novastar MCTRL600 (THAI)      |
| CRD20003/00   | Controller Novastar MCTRL660 (EU)        |
| CRD20003/17   | Controller Novastar MCTRL660 (US)        |
| CRD20003/05   | Controller Novastar MCTRL660 (HK)        |
| CRD20003/75   | Controller Novastar MCTRL660 (CN/AUS)    |
| CRD20003/67   | Controller Novastar MCTRL660 (THAI)      |
| CRD20004/00   | Controller Novastar MCTRL660PRO (EU)     |
| CRD20004/17   | Controller Novastar MCTRL660PRO (US)     |
| CRD20004/05   | Controller Novastar MCTRL660PRO (HK)     |
| CRD20004/75   | Controller Novastar MCTRL660PRO (CN/AUS) |
| CRD20004/67   | Controller Novastar MCTRL660PRO (THAI)   |
| CRD20005/00   | Controller Novastar VX4U (EU)            |
| CRD20005/17   | Controller Novastar VX4U (US)            |
| CRD20005/05   | Controller Novastar VX4U (HK)            |
| CRD20005/75   | Controller Novastar VX4U (CN/AUS)        |
| CRD20005/67   | Controller Novastar VX4U (THAI)          |
| CRD20006/00   | Controller Novastar VX6S (EU)            |

| <b>CTN</b>  | <b>Commercial description</b>            |
|-------------|--|
| CRD20006/17 | Controller Novastar VX6S (US)            |
| CRD20006/05 | Controller Novastar VX6S (HK)            |
| CRD20006/75 | Controller Novastar VX6S (CN/AUS)        |
| CRD20006/67 | Controller Novastar VX6S (THAI)          |
| CRD20007/00 | Controller Novastar MCTRLR5 (EU)         |
| CRD20007/17 | Controller Novastar MCTRLR5 (US)         |
| CRD20007/05 | Controller Novastar MCTRLR5 (HK)         |
| CRD20007/75 | Controller Novastar MCTRLR5 (CN/AUS)     |
| CRD20007/67 | Controller Novastar MCTRLR5 (THAI)       |
| CRD20008/00 | Controller Novastar MCTRL4K (EU)         |
| CRD20008/17 | Controller Novastar MCTRL4K (US)         |
| CRD20008/05 | Controller Novastar MCTRL4K (HK)         |
| CRD20008/75 | Controller Novastar MCTRL4K (CN/AUS)     |
| CRD20008/67 | Controller Novastar MCTRL4K (THAI)       |
| CRD20009/00 | Controller Novastar TB3 (EU)             |
| CRD20009/17 | Controller Novastar TB3 (US)             |
| CRD20009/05 | Controller Novastar TB3 (HK)             |
| CRD20009/75 | Controller Novastar TB3 (CN/AUS)         |
| CRD20009/67 | Controller Novastar TB3 (THAI)           |
| CRD20010/00 | Controller Novastar TB6 (EU)             |
| CRD20010/17 | Controller Novastar TB6 (US)             |
| CRD20010/05 | Controller Novastar TB6 (HK)             |
| CRD20010/75 | Controller Novastar TB6 (CN/AUS)         |
| CRD20010/67 | Controller Novastar TB6 (THAI)           |
| CRD20011/00 | Controller Novastar TB8 (EU)             |
| CRD20011/17 | Controller Novastar TB8 (US)             |
| CRD20011/05 | Controller Novastar TB8 (HK)             |
| CRD20011/75 | Controller Novastar TB8 (CN/AUS)         |
| CRD20011/67 | Controller Novastar TB8 (THAI)           |
| BZ110090/00 | P.cable, Schuko EU/IND to C13/1.8M/10x   |
| BZ110090/05 | Power cable, UK/HK to C13/1.8M/10x       |
| BZ110090/17 | Power cable, US/TWN to C13/1.8M/10x      |
| BZ110090/75 | Power input cable, AUS to C13/1.8M/10x   |
| BZ110090/67 | Power input cable, THAI to C13/1.8M/10x  |
| BZ110089/00 | RJ45 cable CAT5 /1.1m / black / 20x      |
| BZ110088/00 | RJ45 cable CAT5 / 65cm / black / 20x     |
| BZ110087/00 | PWR LOOP THR/C13-C14/25cm/black/20x      |
| BZ110086/00 | PWR LOOP THR/C13-C14/60cm/black/20x      |
| BZ110085/00 | PWR LOOP THR/C13-C14/1M/black/20x        |
| BZ110084/00 | LED module flatcable 45cm                |
| BZ110083/00 | LED module flatcable 25cm                |
| BM107000/00 | Service Tool kit 7/8/9000-Charger/3Ah    |
| BM107001/00 | Front Tool Battery 7/8/9000, 3Ah         |
| BM199005/00 | Toolbox 7/8/9000 M10/3xT-Hex/SD/ASGL/USB |
| BZ207000/00 | PSU 7000-series                          |
| BZ307000/00 | HUB board 7000-series                    |
| CRD20086/00 | Novastar Receiving card, A5S 7xxx        |
| BM907001/00 | Connecting plate 73xx 90 deg. 10x        |
| BM907000/00 | Connecting plate 7000 180 deg. 20x       |

| <b>CTN</b>  | <b>Commercial description</b>            |
|-------------|--|
| BM907002/00 | Connecting plate 73xx 177.5 deg. 20x     |
| BM907003/00 | Connecting plate 73xx, 175 degree 20x    |
| BM907004/00 | Connecting plate 73xx, 172.5 deg. 20x    |
| BM907006/00 | Connecting plate 7000 to 4x4cm extr. 10x |
| BM907009/00 | Connecting plate 7000 M-br. 4x4 extr 24x |
| BM907010/00 | Base bar 72xx 180 degree, 1M 1x          |
| BM907011/00 | Base bar 72xx 180 degree, 25cm 1x        |
| BM907005/00 | Screw bolt, M10*20 inner hex 1000x       |
| BM907007/00 | LED Diode 7000-serie XC1515 P1.9/2.4     |
| BM907008/00 | LED Mask for P2.4mm, 7000-serie, XC1515c |

## Appendix D. Technical Specifications

| <b>Picture/Display</b>                        |  |
|---|--|
| Peak brightness (nits)                        | 1600*  |
| Max. brightness (nits)                        | ±1200*   |
| Color Temperature (K) default                 | 6500±500   |
| Color Temperature (K) adjust range            | 4000–9500 (by software)  |
| Viewing Angle (°) H/V                         | 160/160  |
| Brightness Uniformity                         | ≥97%   |
| Transparent rate(%)                           | N/A  |
| Color Uniformity                              | ±0.012Cx,Cy  |
| Color coordinates                             | 0.313, 0.325 (±0.012Cx,Cy)   |
| Peak contrast ratio                           | 6500:1   |
| Max. contrast ratio                           | 5000:1   |
| Calibration (Brightness/Color)                | Color and Brightness   |
| Bit-depth (bit)                               | 13-16  |
| Scan rate (lines)                             | 26   |
| Refresh rate (Hz)                             | 2100-3900 (14 bits: 3900Hz)  |
| Frame Frequency (Hz)                          | 50 & 60  |
| * According to IDMS standard.                 |  |
| <b>Power</b>                                  |  |
| Max. power consumption before calibration (W) | <150   |
| Max. power consumption after calibration (W)  | <105   |
| Cabinet Typical Power consumption (W)         | <35  |
| Cabinet black screen consumption (W)          | <11  |
| Input Voltage                                 | AC100-240V (50 & 60Hz)   |
| <b>Operating conditions</b>                   |  |
| Operation Temperature                         | -20°C–45°C   |
| Storage Temperature                           | -20°C–50°C   |
| Operation Humidity                            | 10-80%   |
| Storage Humidity                              | 10-85%   |
| <b>Miscellaneous</b>                          |  |
| Warranty                                      | 2 years  |
| Regulatory approvals                          | FCC SDOC, Part 15 Class A  |
| Certification                                 | EN55032, EN55035, EN61000-3-2, EN61000-3-3, IEC/UL60950, IEC/UL62368, CSA/UL62368-1, IEC62471, EAC, RoHS, IP Rating test, Fire Retardancy Certification: BS476, UL94, B1 DIN4102 |

| <b>Cabinet</b>                        |  |
|---------------------------------------|--|
| Cabinet Size W/O Module (WxHxD in mm) | 1000x250x40                                |
| Side angle (degree)                   | 90   |
| Cabinet Size (inch)                   | 40.6"                                      |
| Cabinet Resolution (W×H in pixels)    | 416x104                                    |
| Receiving card brand                  | Novastar                                   |
| Receiving card type                   | A5S/A5S plus                               |
| Weight (W/O packing and accessories)  | 5.89Kg (±120g)                             |
| Cabinet pixels (Dot)                  | 43.264                                     |
| Cabinet Area (m2)                     | 0.25                                       |
| Data connector                        | RJ45                                       |
| Power connector                       | 3 core socket (C14 in, C13 out)            |
| Cabinet Construction                  | Die-Casting+Aluminum 90°                   |
| <b>Module</b>                         |  |
| LED Type                              | SMD 1515 Copper wire                       |
| Pixel constitution                    | 1R1G1B                                     |
| LED Lifetime (Hrs)                    | 100,000                                    |
| Pixel Pitch (mm)                      | 2.4  |
| Module Size (WxH in mm)               | 249.9 x 249.9 (tolerance: +0.05 / -0.1)    |
| Module Resolution (W×H in pixels)     | 104 x 104                                  |
| Conformal coating (UV-resistant)      | Yes (LED Module Bottom side and HUB board) |
| <b>Accessories</b>                    |  |
| Power cable (short)                   | 600 mm                                     |
| Power cable (long)                    | 1000 mm                                    |
| LAN cable (RJ45, CAT-5)               | LAN cable (RJ45, CAT-5) (650mm)            |
| LAN cable (RJ45, CAT-5)               | LAN cable (RJ45, CAT-5) (1100mm)           |
| QSG                                   | 1 piece                                    |
| <b>Other</b>                          |  |
| IP rating                             | IP30 for panel side                        |
| Working environment                   | Indoor                                     |

## Appendix E. Power/Data cable measure

### Installation power cable measure

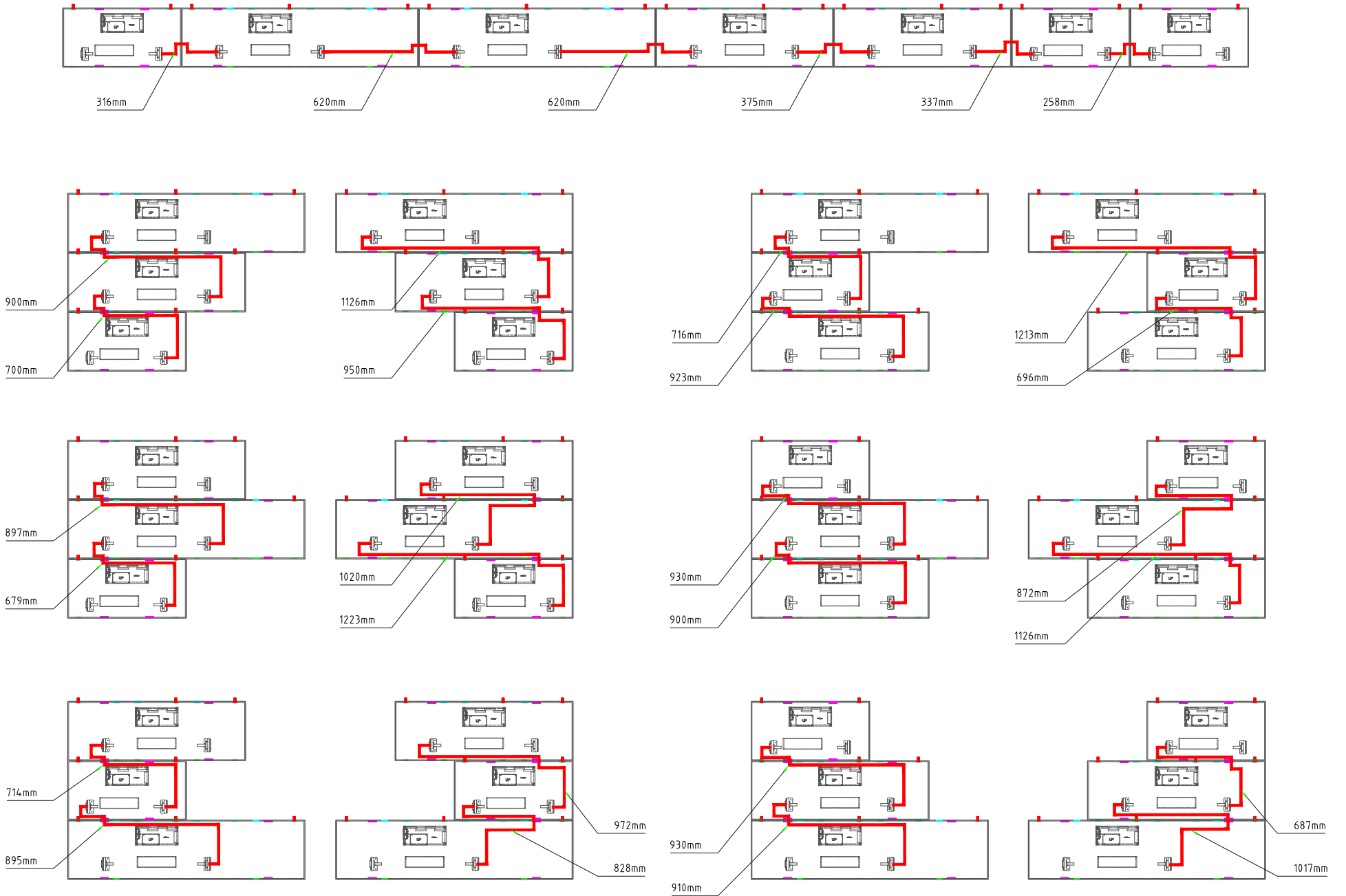

1 Meter Ending Installation

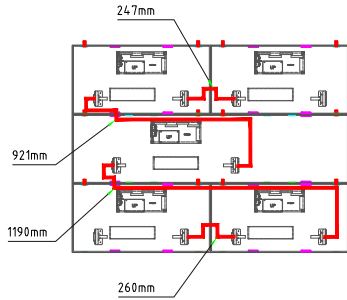

1.5 Meter Ending Installation

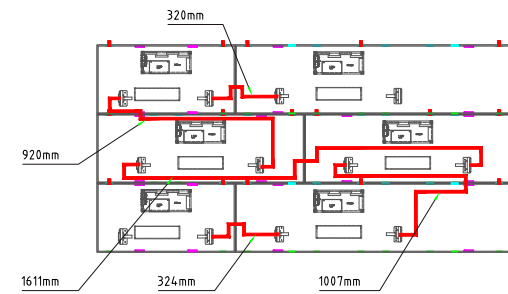
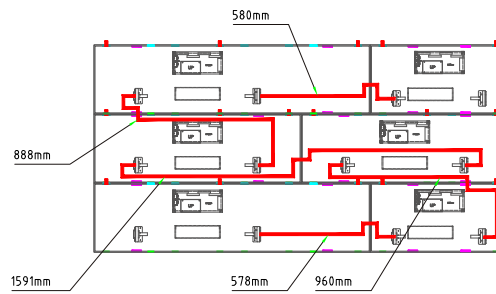
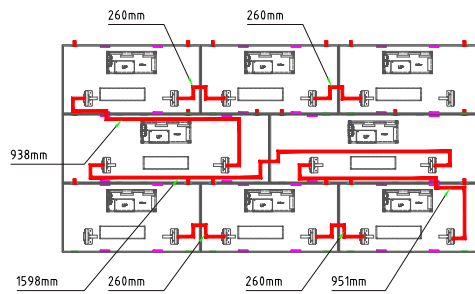

2 Meter Ending Installation

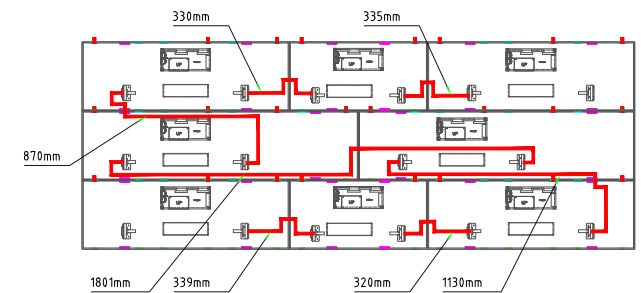
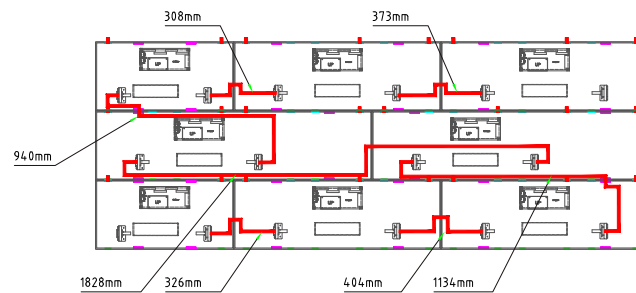
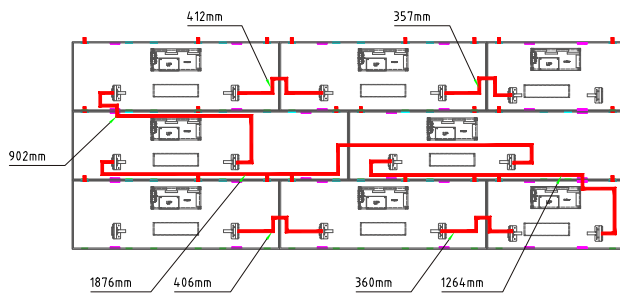

| 22BDL7224L           | 31BDL7224L           | 41BDL7224L           |
|----------------------|----------------------|----------------------|
| Power cable (250mm)  | Power cable (600mm)  | Power cable (600mm)  |
| Power cable (1000mm) | Power cable (1000mm) | Power cable (1000mm) |



Installation data cable measure

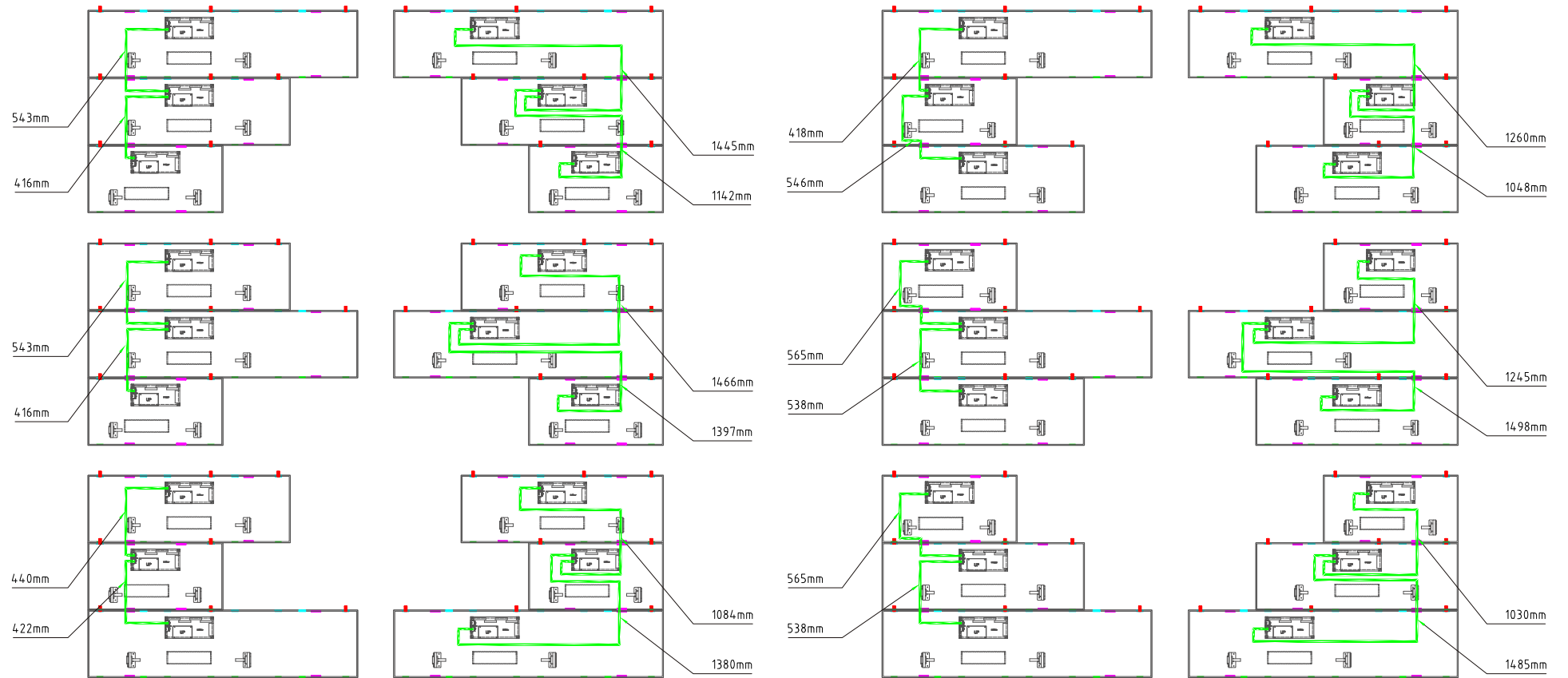

### 1 Meter Ending Installation

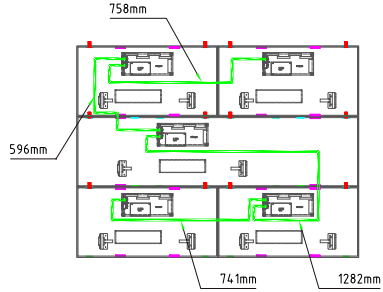

### 1.5 Meter Ending Installation

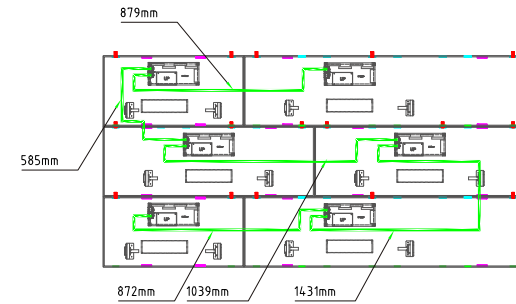
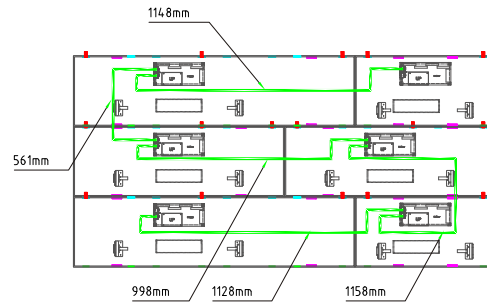
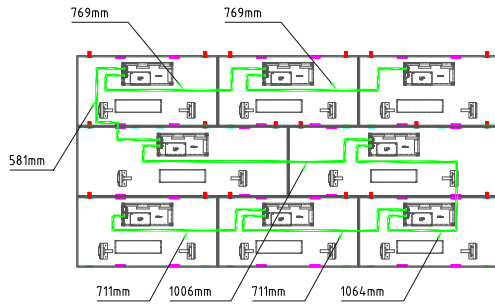

### 2 Meter Ending Installation

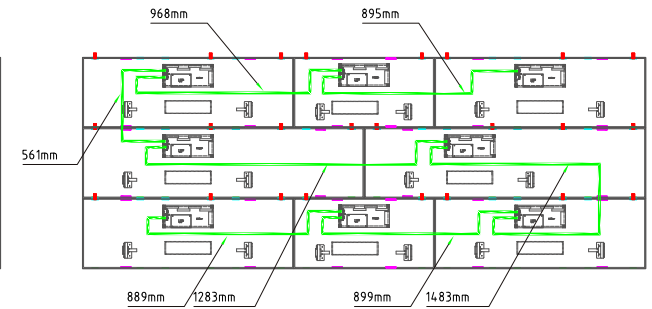
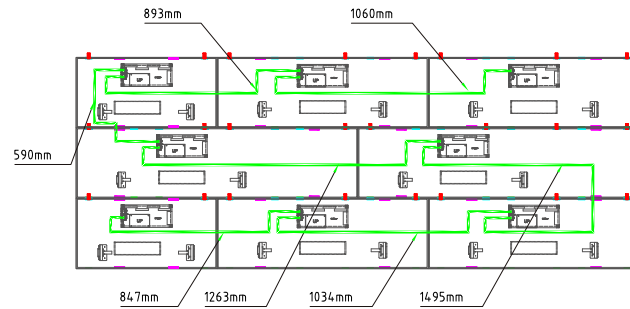
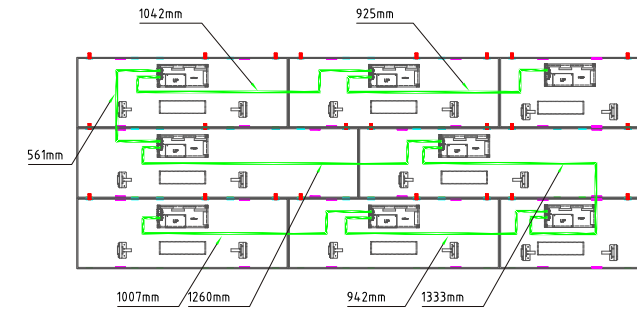

| 22BDL7224L                                   | 31BDL7224L                       | 41BDL7224L                       |
|--|----------------------------------|----------------------------------|
| LAN cable (RJ45, CAT-5) (650mm)<br>(H and V) | LAN cable (RJ45, CAT-5) (650mm)  | LAN cable (RJ45, CAT-5) (650mm)  |
|  | LAN cable (RJ45, CAT-5) (1100mm) | LAN cable (RJ45, CAT-5) (1100mm) |

## Appendix F. Mounting scheme

Below you will find some configuration examples for mounting scheme.

Manufacturer Default Alignment Pin

Alignment screw thread hole

Alignment hole

Opening for cable

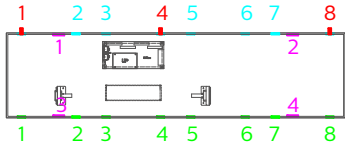

L-4-3-2 Installation

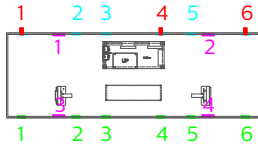
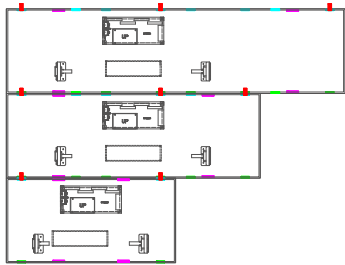

R-4-3-2 Installation

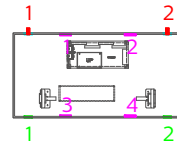
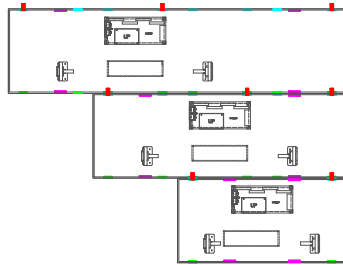

L-4-2-3 Installation

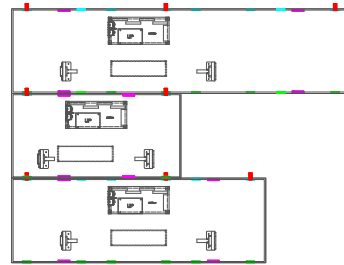

R-4-2-3 Installation

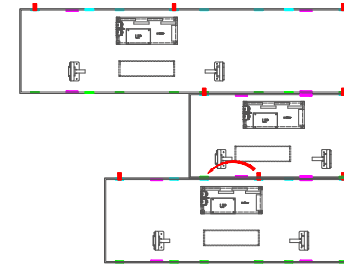

move 1 alignment pin

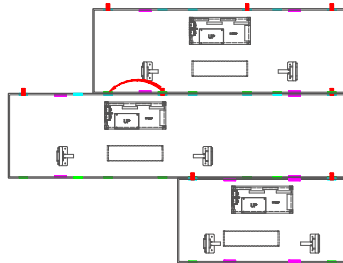
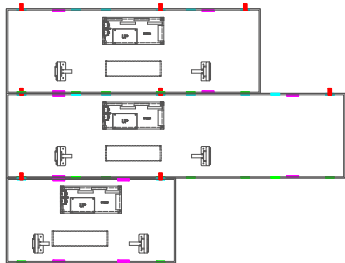

move 1 alignment pin

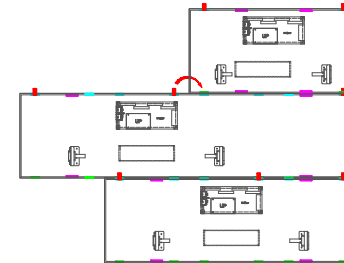
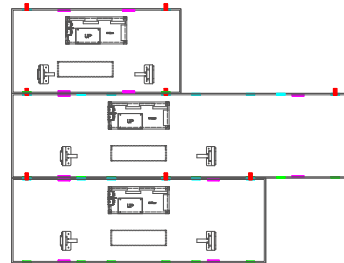

move 1 alignment pin

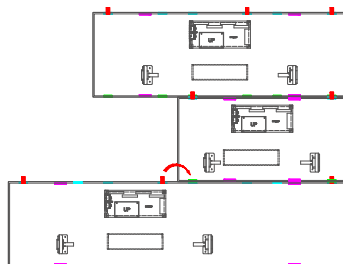
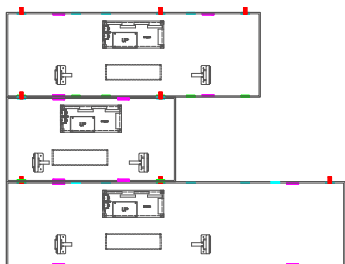

move 1 alignment pin

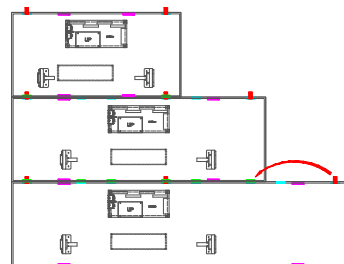

move 1 alignment pin

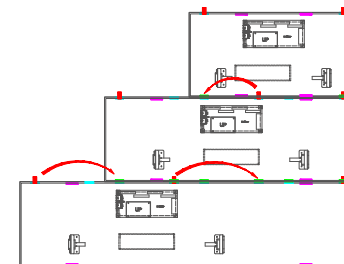

move 3 alignment pins

### 1 Meter Ending Installation

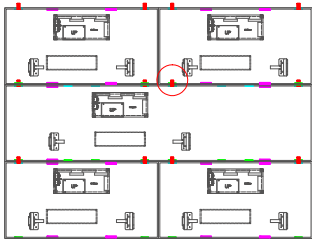

add 1 alignment pin

### 1.5 Meter Ending Installation

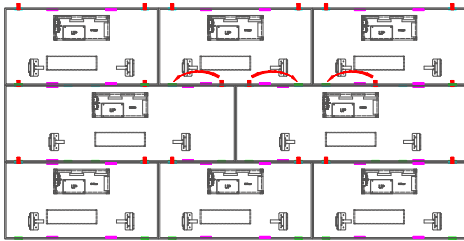

add 3 alignment pins

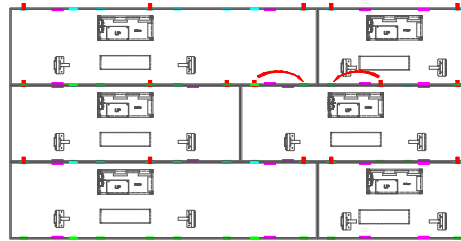

move 2 alignment pins

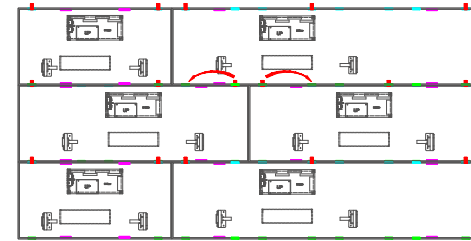

move 2 alignment pins

### 2 Meter Ending Installation

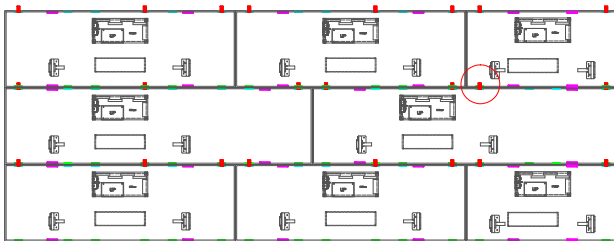

add 1 alignment pin

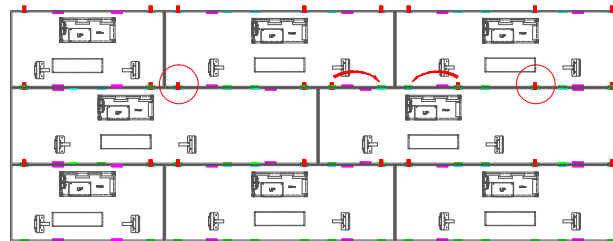

add 2 alignment pins  
move 2 alignment pins

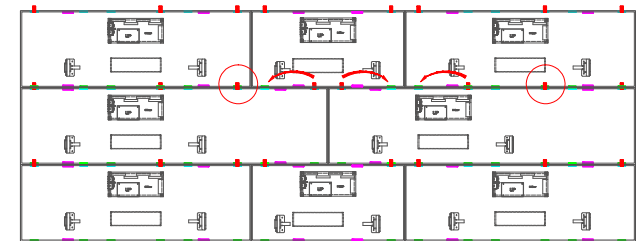

add 2 alignment pins  
move 3 alignment pins



2020 © TOP Victory Investments Ltd. All rights reserved.

This product has been manufactured by and is sold under the responsibility of Top Victory Investments Ltd., and Top Victory Investments Ltd. is the warrantor in relation to this product. Philips and the Philips Shield Emblem are registered trademarks of Koninklijke Philips N.V. and are used under license.

Specifications are subject to change without notice.